

EGTS

EXHAUST GAS TEMPERATURE SENSOR

ABGASTEMPERSORSOR



NTC



2021

3rd EDITION



www.mte-thomson.com.br

TECHNICAL INFORMATION 5, 6, 7

PRODUCTS

9001	FORD - VOLVO	8
9002	FORD	9
9003	FORD	9
9004	FORD	10
9005	FORD	10
9006	OPEL - RENAULT	10, 11
9007	RENAULT	11
9008	DACIA - RENAULT	11, 12
9009	NISSAN - RENAULT	12
9010	RENAULT	13
9011	DACIA - OPEL - RENAULT	13, 14
9012	AUDI - SEAT - SKODA - VOLKSWAGEN	14, 15
9013	AUDI - SEAT - SKODA - VOLKSWAGEN	15, 16
9014	VOLKSWAGEN	17
9015	AUDI - SEAT	17
9016	AUDI - VOLKSWAGEN	17, 18
9017	AUDI - SEAT - SKODA - VOLKSWAGEN	18
9020	BMW	19
9021	BMW	19
9022	BMW	20
9023	BMW	20
9024	BMW	20
9025	BMW	21
9026	BMW	21
9027	BMW	22
9031	AUDI - SEAT	22
9032	AUDI - VOLKSWAGEN	23
9038	BMW	23
9039	BMW	24
9040	BMW	24



PRODUCTS

9041	FORD	24
9042	FORD	25
9044	FORD	25
9046	FORD	25
9049	FORD	26
9051	RENAULT	26
9052	RENAULT	26
9056	SEAT - VOLKSWAGEN	27
9057	AUDI - SEAT - SKODA - VOLKSWAGEN	27, 28
9058	AUDI - SEAT	29
9059	SEAT - SKODA - VOLKSWAGEN	29
9060	VOLKSWAGEN	30
9061	AUDI - SEAT - SKODA - VOLKSWAGEN	30, 31
9062	AUDI - SEAT - SKODA - VOLKSWAGEN	31, 32
9063	AUDI - SEAT - SKODA - VOLKSWAGEN	32, 33
9064	AUDI - SEAT - SKODA - VOLKSWAGEN	33, 34
9065	AUDI - SEAT - SKODA - VOLKSWAGEN	34
9066	VOLKSWAGEN	35
9067	VOLKSWAGEN	35
9068	VOLKSWAGEN	35
9069	VOLKSWAGEN	36
9070	AUDI	36
9071	AUDI - SEAT - SKODA - VOLKSWAGEN	36, 37
9076	FORD	37

CROSS REFERENCE	38, 39, 40, 41
------------------------	----------------



EGTS SENSOR

NTC



EXHAUST GAS TEMPERATURE SENSOR ABGASTEMPÉRATURSENSOR



An **Exhaust Gas Temperature Sensor (EGTS)** detects exhaust gas temperature, converts it into a voltage and feeds that voltage signal back to the engine **ECU**, in order to control engine conditions and effectively reduce emissions.

Exhaust Gas Temperature Sensors (EGTS) are located:

- **T3** – before the Turbocharger (**TBC**).
- **T4** – after the Turbocharger (**TBC**).
- **T5** – before/after Diesel Oxidation Catalyst (**DOC**).
- **T6** – before/after Diesel Particulate Filter (**DPF**) and Selective Catalytic Reduction (**SCR**).
- **TEGR** – before/after High-Pressure **EGR** Cooling System.

Exhaust Gas Temperature Measurement Points - Diesel

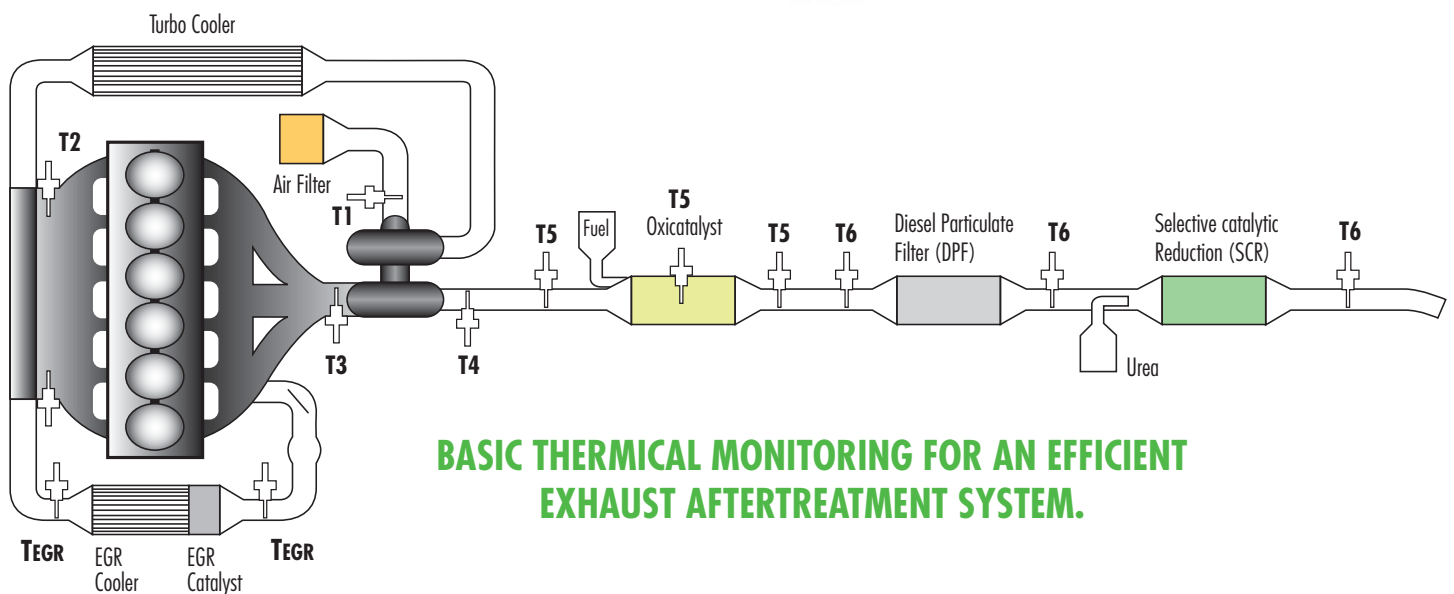

BASIC THERMAL MONITORING FOR AN EFFICIENT EXHAUST AFTERTREATMENT SYSTEM.

With the assistance of the different **EGTS** signals, the exhaust gas treatment devices can operate in their optimal conditions and their functionalities are constantly verified (**OBD – On-Board Diagnostics**).

For instance:

- The Temperature Probes before and after the Turbocharger are used to verify whether a temperature decrease (aprox. 150°C) occurred.
- The **DOC** and the **SCR** need to achieve a minimum operation temperature, respectively 140°C and 190°C.
- The Temperatures before the Turbocharger, after the **DPF** and in the **DOC** are also monitored in order to avoid overheating of these components.
- The performances of the temperatures after and before the **DPF** (together with the Differential Pressure Sensor's signal) are used to verify a successful regeneration of that component.

EGTS SENSOR

NTC



EXHAUST GAS TEMPERATURE SENSOR ABGASTEMPÉRATURSENSOR

TECHNOLOGIES:

MTE-THOMSON manufactures two different technologies of EGTS, NTC Thermistor and PT200. This way we can offer a complete range in the aftermarket.

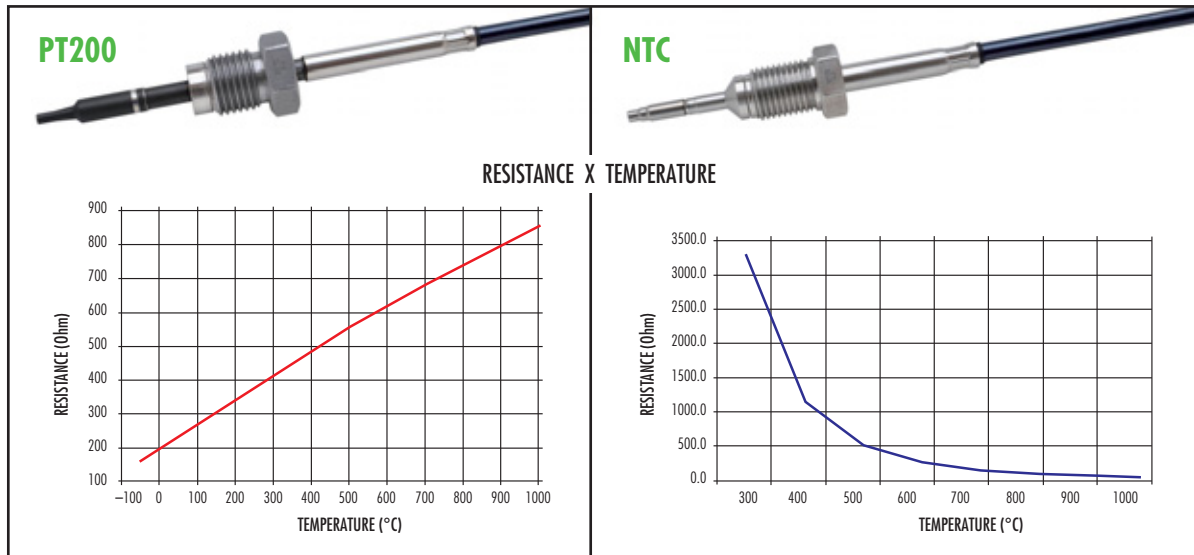

APPLICATION:

The signal is measured using a Voltage-Divider. Most ECUs use a 2.2 kOhms pull-up resistor.

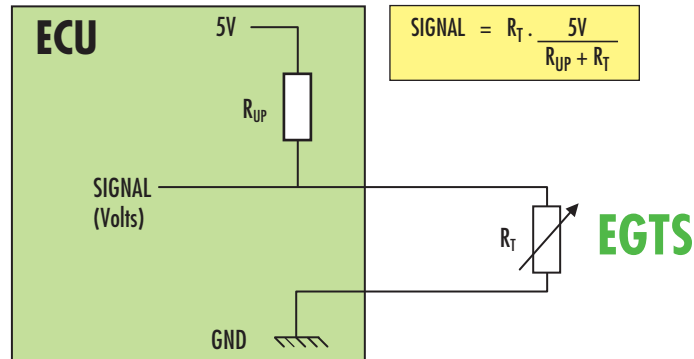

SIGNALS: PT200 x NTC

A comparison between the signals of a NTC and a Pt200 EGTS can be seen below. In this example it was used a pull-up resistor of 1000 Ohms and a 5V voltage supply.

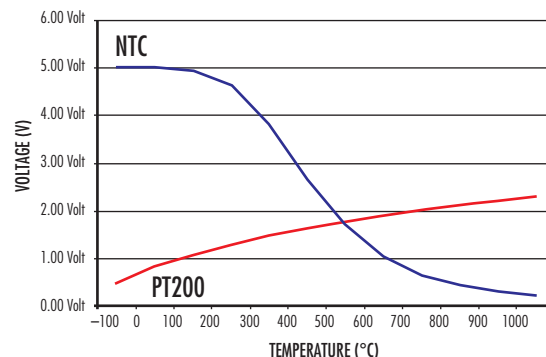

COMPONENTS:

- **Closed Stainless Cover:** Protects the sensor element against corrosion atmosphere and water drops from the exhaust.
- **NTC Thermistor:** Negative Temperature Coefficient ceramic element.
- **PT200:** Platinum element with Positive Temperature Coefficient, which has a resistance of 200 Ohms at 0°C.
- **MIC:** Mineral Isolated Cable that separates the hot part from the cold part.
- **Wires:** Teflon insulated – oil, gas and water resistant. Stranded wire – Greater flexibility
- **Connectors:** PA+GF. OEM Quality

MALFUNCTION:

Malfunctions of the Temperature Probes can lead to:

- Unnecessary filter regeneration, leading to a reduction in the filter's lifespan;
- Power losses if the sensor is not detecting the filter saturation level;
- Dashboard light for Particulate Filter and blinking light pre-heating;
- Deterioration of Turbocharger, DOC, SCR components and DPF;
- Increase in oil consumption;
- Increase in emission levels of CO, NOx and HC.

QUALITY

The EGTS from MTE-THOMSON is produced with the best raw materials, with automated processes and is tested 100% with OEM expertise.

GUARANTEE

All MTE-THOMSON products are guaranteed for 01 (one) year against defects from faulty materials or fabrication. The guarantee is limited to the replacement of the faulty part; we cannot extend the guarantee to cover defects caused by misuse, neglect, accident or wear, and tear. We cannot accept liability for consequential loss or damage which is claimed to have resulted from the use of one of our products.

More information: www.mte-thomson.com.br



EGTS SENSOR

NTC



EXHAUST GAS TEMPERATURE SENSOR ABGASTEMPÉRATURSENSOR

PRODUCT	MODEL	ENGINE	FUEL	YEAR	POSITION
 <p>9001</p>	FORD				
	C-MAX II	1.6 TDCi	DIESEL	10/	PRE CAT
	FOCUS II	1.6 TDCi	DIESEL	04/12	PRE DPF
	FOCUS III	1.6 TDCi	DIESEL	10/	PRE DPF
	GALAXY	1.6 TDCi	DIESEL	11/15	PRE DPF
	GALAXY	2.0 TDCi	DIESEL	07/15	PRE DPF
	GRAND C-MAX	1.6 TDCi	DIESEL	10/	PRE DPF
	MONDEO IV	1.6 TDCi	DIESEL	10/15	PRE DPF
	S-MAX	1.6 TDCi 2.0 TDCi	DIESEL DIESEL	11/14 06/14	PRE DPF PRE DPF
	#OEM 6G91-12B59-1DA 6S71-12B591-C 1406177				
	VOLVO				
	C30	1.6 D2	DIESEL	10/12	PRE DPF
	S40 II	1.6 D2	DIESEL	10/12	PRE DPF
	S60 II	1.6 D2	DIESEL	11/15	PRE DPF
	S80 II	1.6 DRIVe 2.0 TDI	DIESEL DIESEL	11/ 08/11	PRE DPF PRE DPF
	V40	1.6 D2	DIESEL	12/	PRE DPF
	V50	1.6 D2	DIESEL	10/12	PRE DPF
	V60 I	1.6 DRIVe	DIESEL	11/15	PRE DPF
	V70 III	1.6 DRIVe 2.0 D	DIESEL DIESEL	11/15 07/15	PRE DPF PRE DPF

#OEM 30777344

EGTS SENSOR

NTC



EXHAUST GAS TEMPERATURE SENSOR ABGASTEMPÉRATURSENSOR

PRODUCT	MODEL	ENGINE	FUEL	YEAR	POSITION
 <p>9002</p>	FORD				
	C-MAX	1.8 TDGi 2.0 TDGi	DIESEL DIESEL	07/10 07/10	PRE CAT PRE CAT
	FOCUS II	1.8 TDGi 2.0 TDGi	DIESEL DIESEL	05/12 08/11	PRE CAT PRE CAT
	GALAXY	2.0 TDGi 2.2 TDGi	DIESEL DIESEL	06/15 08/12	PRE CAT PRE DPF
	KUGA	2.0 TDGi	DIESEL	08/12	PRE CAT
	MONDEO III	2.0 TDGi 2.2 TDGi	DIESEL DIESEL	00/07 04/07	PRE CAT PRE CAT
	MONDEO IV	2.0 TDGi 2.2 TDGi	DIESEL DIESEL	07/15 08/10	PRE DPF PRE DPF
	RANGER	2.2 TDGi 3.2 TDGi	DIESEL DIESEL	08/10 11/	POST CAT POST CAT
	S-MAX	2.0 TDGi 2.2 TDGi	DIESEL DIESEL	07/14 08/12	PRE CAT PRE DPF
	TOURNEO	1.8 TDCI	DIESEL	02/13	PRE DPF
	TRANSIT	1.8 TDCI	DIESEL	02/13	PRE DPF

#OEM 6S71-12B59-1BA - 9V41-12B591-AA - 1381181 - 1480867 - 1543768

PRODUCT	MODEL	ENGINE	FUEL	YEAR	POSITION
 <p>9003</p>	FORD				
	B-MAX	1.5 TDGi 1.6 TDGi	DIESEL DIESEL	12/ 12/	PRE DPF PRE DPF
	FIESTA VI	1.4 TDGi 1.5 TDGi 1.6 TDGi	DIESEL DIESEL DIESEL	09/ 12/ 08/	PRE CAT PRE CAT PRE CAT
	TRANSIT	2.2 TDCI 2.4 TDCI	DIESEL DIESEL	06/14 06/14	PRE CAT PRE CAT





#OEM 8C11-12B59-1CA - 1455174 - 1496243

EGTS SENSOR





NTC







EXHAUST GAS TEMPERATURE SENSOR ABGASTEMPERATURSENSOR

PRODUCT	MODEL	ENGINE	FUEL	YEAR	POSITION
9004 	FORD				
	KUGA	2.0 TDCi	DIESEL	08/12	PRE DPF
	TOURNEO	1.6 TDCi	DIESEL	13/	PRE DPF
	TRANSIT	1.6 TDCi	DIESEL	13/	PRE DPF

#OEM 8V41-12B59-1BA - 1508575

PRODUCT	MODEL	ENGINE	FUEL	YEAR	POSITION
9005 	FORD				
	EDGE	2.0 TDCi	DIESEL	15/18	PRE DPF
	GALAXY	2.0 TDCi	DIESEL	06/15	PRE DPF
		2.2 TDCi	DIESEL	10/15	PRE DPF
	MONDEO IV	2.0 TDCi	DIESEL	07/15	PRE DPF
2.2 TDCi		DIESEL	10/15	PRE DPF	
S-MAX	2.0 TDCi	DIESEL	06/14	PRE DPF	
	2.2 TDCi	DIESEL	10/14	PRE DPF	

#OEM AG91-12B59-1AA

PRODUCT	MODEL	ENGINE	FUEL	YEAR	POSITION
9006 	OPEL				
	MOVANO	2.5 CDTi	DIESEL	03/	PRE TURBO

#OEM 4433537 - 93198108





CONTINUING...

EGTS SENSOR





NTC







EXHAUST GAS TEMPERATURE SENSOR ABGASTEMPERATURSENSOR

PRODUCT	MODEL	ENGINE	FUEL	YEAR	POSITION
9006 	RENAULT				
	ESPACE IV	2.2 dCi	DIESEL	06/	PRE TURBO
	LAGUNA II	2.2 dCi	DIESEL	05/07	POST TURBO
	TRAFIC II	2.5 dCi	DIESEL	06/	PRE TURBO
	VEL SATIS	2.2 dCi	DIESEL	04/	PRE TURBO

#OEM 82.00.629.249 - 82.00.673.215

PRODUCT	MODEL	ENGINE	FUEL	YEAR	POSITION
9007 	RENAULT				
	GRAND SCENIC II	1.9 dCi	DIESEL	04/09	PRE TURBO
	GRAND SCENIC III	1.9 dCi	DIESEL	09/	PRE TURBO
	LAGUNA II	1.9 dCi	DIESEL	05/07	PRE TURBO
	MEGANE CC	1.9 dCi	DIESEL	10/	PRE TURBO
	MEGANE II	1.9 dCi	DIESEL	02/08	PRE TURBO
	MEGANE III	1.9 dCi	DIESEL	08/	PRE TURBO

#OEM 82.00.513.321 - 82.00.626.456 - 82.00.897.221

PRODUCT	MODEL	ENGINE	FUEL	YEAR	POSITION
9008 	DACIA				
	DUSTER	1.5 dCi	DIESEL	10/18	PRE TURBO
	LOGAN	1.5 dCi	DIESEL	10/	POST TURBO
	SANDERO	1.5 dCi	DIESEL	10/	POST TURBO

#OEM 82.00.872.039

CONTINUING...

EGTS SENSOR

NTC



EXHAUST GAS TEMPERATURE SENSOR ABGASTEMPERATURSENSOR

PRODUCT	MODEL	ENGINE	FUEL	YEAR	POSITION
 <p>9008</p>	RENAULT				
	CLIO III	1.5 dCi	DIESEL	10/	PRE TURBO
	FLUENCE	1.5 dCi	DIESEL	10/	PRE TURBO
	KANGOO	1.5 dCi	DIESEL	08/	PRE TURBO
	LAGUNA III	1.5 dCi	DIESEL	07/15	PRE TURBO
	LATITUDE	1.5 dCi	DIESEL	10/	PRE TURBO
	MEGANE III	1.5 dCi	DIESEL	08/	PRE TURBO
	MODUS	1.5 dCi	DIESEL	10/	PRE TURBO
	TWINGO II	1.5 dCi	DIESEL	10/	PRE TURBO
#OEM 82.00.929.533					

PRODUCT	MODEL	ENGINE	FUEL	YEAR	POSITION	
 <p>9009</p>	NISSAN					
	QASHQAI	2.0 dCi	DIESEL	07/13	PRE TURBO	
	X-TRAIL	2.0 dCi	DIESEL	07/13	PRE TURBO	
	#OEM 22365-00QAF					
	RENAULT					
	ESPACE IV	2.0 dCi	DIESEL	06/	PRE TURBO	
	GRAND SCENIC	2.0 dCi	DIESEL	05/08	PRE TURBO	
	KOLEOS I	2.0 dCi	DIESEL	08/	PRE TURBO	
	LAGUNA	2.0 dCi	DIESEL	08/15	PRE TURBO	
	LAGUNA II	2.0 dCi	DIESEL	06/07	PRE TURBO	
LAGUNA III	2.0 dCi	DIESEL	07/15	PRE TURBO		
MEGANE II	2.0 dCi	DIESEL	05/09	PRE TURBO		
VEL SATIS	2.0 dCi	DIESEL	05/	PRE TURBO		
#OEM 82.00.941.746 - 82.00.640.532 - 82.00.882.195						

EGTS SENSOR

NTC



EXHAUST GAS TEMPERATURE SENSOR ABGASTEMPERATURSENSOR

PRODUCT	MODEL	ENGINE	FUEL	YEAR	POSITION
9010 	RENAULT				
	LAGUNA	3.0 dCi	DIESEL	12/15	PRE TURBO
	LAGUNA III	3.0 dCi	DIESEL	08/15	PRE TURBO
	LATITUDE	3.0 dCi	DIESEL	11/	PRE TURBO
	MEGANE II	1.5 dCi	DIESEL	06/09	PRE TURBO
	MODUS	1.5 dCi	DIESEL	07/	PRE TURBO
	SCÉNIC II	1.5 dCi	DIESEL	05/08	PRE TURBO

#OEM 82.00.670.145 - 82.00.689.052 - 82.00.773.560 - 82.00.014.126

PRODUCT	MODEL	ENGINE	FUEL	YEAR	POSITION
9011 	DACIA				
	DOKKER	1.5 dCi	DIESEL	12/	POST TURBO
	DUSTER	1.5 dCi	DIESEL	10/18	POST TURBO
	LOGGY	1.5 dCi	DIESEL	12/	POST TURBO
	LOGAN II	1.5 dCi	DIESEL	12/	POST TURBO
	SANDERO	1.5 dCi	DIESEL	12/	POST TURBO
	#OEM 82.00.921.749				
	OPEL				
	VIVARO B	1.6 CDTi	DIESEL	14/	PRE TURBO
	RENAULT				
	ALASKAN	2.3 dCi	DIESEL	17/	PRE TURBO
	CAPTUR	1.5 dCi	DIESEL	13/	PRE TURBO
	CLIO III	1.5 dCi	DIESEL	08/12	PRE TURBO
CLIO IV	1.5 dCi	DIESEL	12/	PRE TURBO	

#OEM 82.00.921.749 - 22.64.052.22R - 22.64.052.27R

CONTINUING...

EGTS SENSOR

NTC



EXHAUST GAS TEMPERATURE SENSOR ABGASTEMPATURSENSOR

PRODUCT	MODEL	ENGINE	FUEL	YEAR	POSITION
 <h2>9011</h2>	RENAULT				
	FLUENCE	1.5 dCi 1.6 dCi	DIESEL DIESEL	14/ 14/	PRE TURBO POST TURBO
	GRAND SCÉNIC III	1.5 dCi 1.6 dCi	DIESEL DIESEL	10/ 11/	PRE TURBO PRE DPF
	KADJAR	1.6 dCi	DIESEL	15/	PRE DPF
	KANGOO	1.5 dCi	DIESEL	10/	PRE TURBO
	LAGUNA	1.5 dCi	DIESEL	12/15	PRE TURBO
	MASTER III	2.3 dCi	DIESEL	14/	PRE TURBO
	MEGANE CC	1.6 dCi	DIESEL	11/	PRE TURBO
	MEGANE III	1.5 dCi	DIESEL	14/	PRE TURBO
	MEGANE IV	1.6 dCi	DIESEL	16/	PRE TURBO
	SCENIC III	1.5 dCi 1.6 dCi	DIESEL DIESEL	10/ 11/	PRE TURBO PRE DPF
	TALISMAN	1.6 dCi	DIESEL	15/	PRE TURBO
	THALIA III	1.5 dCi	DIESEL	14/	PRE TURBO
	TRAFIC III	1.6 dCi	DIESEL	14/	PRE TURBO/DPF

#OEM 82.00.921.749 - 22.64.052.22R - 22.64.052.27R

PRODUCT	MODEL	ENGINE	FUEL	YEAR	POSITION
 <h2>9012</h2>	AUDI				
	A3	2.0 TDI 2.0 TDI 16V	DIESEL DIESEL	03/12 03/12	PRE DPF PRE DPF
	TT	2.0 TDI quattro	DIESEL	08/14	PRE DPF
	#OEM 03L.906.088.BH				
	SEAT				
ALTEA	2.0 TDI 16V	DIESEL	04/	PRE DPF	
ALTEA XL	2.0 TDI 16V	DIESEL	06/	PRE DPF	
LEON	2.0 TDI 16V	DIESEL	05/12	PRE DPF	

#OEM 03L.906.088.BH

CONTINUING...

EGTS SENSOR

NTC



EXHAUST GAS TEMPERATURE SENSOR ABGASTEMPÉRATURSENSOR

PRODUCT	MODEL	ENGINE	FUEL	YEAR	POSITION
 <p>9012</p>	SKODA				
	OCTAVIA III	2.0 TDI	DIESEL	10/12	PRE DPF
	SUPERB II	2.0 TDI	DIESEL	08/15	PRE DPF
	YETI	2.0 TDI	DIESEL	09/17	PRE DPF
	#OEM 03L.906.088.BH				
	VOLKSWAGEN				
	BEETLE	2.0 TDI	DIESEL	10/16	PRE DPF
	CC	2.0 TDI	DIESEL	10/16	PRE DPF
	EOS	2.0 TDI	DIESEL	10/16	PRE DPF
	GOLF PLUS	2.0 TDI	DIESEL	05/13	PRE DPF
	GOLF VI	2.0 TDI	DIESEL	08/13	PRE DPF
	JETTA IV	2.0 TDI	DIESEL	11/	PRE DPF
	PASSAT B7	2.0 TDI	DIESEL	12/14	PRE DPF
	PASSAT CC	2.0 TDI	DIESEL	08/12	PRE DPF
	SCIROCCO III	2.0 TDI	DIESEL	08/17	PRE DPF
	#OEM 03L.906.088.BH				

PRODUCT	MODEL	ENGINE	FUEL	YEAR	POSITION
 <p>9013</p>	AUDI				
	A3	2.0 TDI 2.0 TDI 16V	DIESEL DIESEL	03/12 03/12	POST DPF POST DPF
	Q2	2.0 TDI	DIESEL	16/	POST DPF
	Q3	2.0 TDI	DIESEL	11/18	POST DPF
	TT	2.0 TDI quattro	DIESEL	08/14	POST DPF
	#OEM 03L.906.088.BJ - 03L.906.088.CM - 04L.906.088.AD				

CONTINUING...

PRODUCT	MODEL	ENGINE	FUEL	YEAR	POSITION
 <p>9013</p>	SEAT				
	ALTEA	2.0 TDI 16V	DIESEL	04/	POST DPF
	ALTEA XL	2.0 TDI 16V	DIESEL	06/	POST DPF
	ATECA	2.0 TDI	DIESEL	16/	POST DPF
	LEON	2.0 TDI 16V	DIESEL	05/12	POST DPF
	LEON ST	2.0 TDI	DIESEL	14/	POST DPF
	#OEM 03L.906.088.BJ 03L.906.088.CM 04L.906.088.AD				
	SKODA				
	KAROQ	2.0 TDI	DIESEL	17/	POST DPF
	OCTAVIA III	2.0 TDI	DIESEL	10/12	POST DPF
	OCTAVIA IV	2.0 TDI	DIESEL	12/	POST DPF
	SUPERB II	2.0 TDI	DIESEL	08/15	POST DPF
	YETI	2.0 TDI	DIESEL	09/17	POST DPF
	#OEM 03L.906.088.BJ 03L.906.088.CM 04L.906.088.AD				
	VOLKSWAGEN				
	ARTEON	2.0 TDI	DIESEL	17/	POST DPF
	BEETLE	2.0 TDI	DIESEL	10/16	POST DPF
	CADDY	2.0 TDI	DIESEL	15/	POST DPF
	EOS	2.0 TDI	DIESEL	10/16	POST DPF
	GOLF PLUS	2.0 TDI	DIESEL	05/13	POST DPF
GOLF VII	2.0 TDI	DIESEL	14/	POST DPF	
JETTA IV	2.0 TDI	DIESEL	11/	POST DPF	
PASSAT B8	2.0 TDI	DIESEL	14/	POST DPF	
SCIROCCO III	2.0 TDI	DIESEL	08/17	POST DPF	
TIGUAN	2.0 TDI	DIESEL	08/18	POST DPF	
TOURAN	2.0 TDI	DIESEL	10/15	POST DPF	
T-ROC	2.0 TDI	DIESEL	17/	POST DPF	





#OEM 03L.906.088.BJ - 03L.906.088.CM - 04L.906.088.AD









EGTS SENSOR





NTC



EXHAUST GAS TEMPERATURE SENSOR ABGASTEMPÉRATURSENSOR

PRODUCT	MODEL	ENGINE	FUEL	YEAR	POSITION
9014 	VOLKSWAGEN				
	CC	2.0 TDI	DIESEL	11/16	POST DPF
	PASSAT B7	2.0 TDI	DIESEL	12/14	POST DPF
	PASSAT CC B6	2.0 TDI	DIESEL	08/12	POST DPF
#OEM 03L.906.088.CJ					

PRODUCT	MODEL	ENGINE	FUEL	YEAR	POSITION	
9015 	AUDI					
	A1	2.0 TDI	DIESEL	11/15	PRE DPF	
	#OEM 03L.906.088.CN					
	SEAT					
IBIZA IV	2.0 TDI	DIESEL	10/15	PRE DPF		
#OEM 03L.906.088.CN						

PRODUCT	MODEL	ENGINE	FUEL	YEAR	POSITION
9016 	AUDI				
	A4	2.0 TDI	DIESEL	09/16	PRE TURBO
	A5	2.0 TDI	DIESEL	09/17	PRE TURBO
	Q5	2.0 TDI	DIESEL	09/17	PRE TURBO
#OEM 03L.906.088.A					

CONTINUING...

EGTS SENSOR

NTC



EXHAUST GAS TEMPERATURE SENSOR ABGASTEMPERATURSENSOR

PRODUCT	MODEL	ENGINE	FUEL	YEAR	POSITION
9016	VOLKSWAGEN				
	TOUAREG	2.5 R5 TDI	DIESEL	03/10	PRE TURBO



#OEM 070.906.088.AG

PRODUCT	MODEL	ENGINE	FUEL	YEAR	POSITION
9017	AUDI				
	A1	2.0 TDI	DIESEL	11/15	PRE TURBO
	#OEM 03L.906.088.BK				
	SEAT				
	IBIZA IV	1.6 TDI	DIESEL	09/15	PRE TURBO
	TOLEDO IV	1.6 TDI	DIESEL	10/15	PRE TURBO
	#OEM 03L.906.088.BK				
	SKODA				
	FABIA II	1.6 TDI	DIESEL	10/15	PRE TURBO
	RAPID	1.6 TDI	DIESEL	12/19	PRE TURBO
	ROOMSTER	1.6 TDI	DIESEL	10/15	PRE TURBO
	#OEM 03L.906.088.BK				
	VOLKSWAGEN				
POLO V	1.6 TDI	DIESEL	09/	PRE TURBO	
#OEM 03L.906.088.BK					







EGTS SENSOR





NTC



EXHAUST GAS TEMPERATURE SENSOR ABGASTEMPÉRATURSENSOR

PRODUCT	MODEL	ENGINE	FUEL	YEAR	POSITION				
	BMW SERIE 1 SERIE 3 SERIE 5 X1 X3								
						116 d	DIESEL	08/12	PRE CAT
						118 d	DIESEL	06/12	PRE CAT
						120 d	DIESEL	07/12	PRE CAT
						316 d	DIESEL	09/11	PRE CAT
						318 d	DIESEL	07/11	PRE CAT
						320 d	DIESEL	05/11	PRE CAT
						520 d	DIESEL	05/10	PRE CAT
						530 d	DIESEL	09/	PRE CAT
						535 d	DIESEL	10/	PRE CAT
						18 d	DIESEL	09/	PRE CAT
						20 d	DIESEL	10/	PRE CAT

#OEM 13.62.780.6254

PRODUCT	MODEL	ENGINE	FUEL	YEAR	POSITION				
	BMW SERIE 1 SERIE 3 SERIE 5 SERIE 7 X5								
						118 d	DIESEL	03/12	PRE CAT
						120 d	DIESEL	03/12	PRE CAT
						318 d	DIESEL	05/11	PRE CAT
						320 d	DIESEL	05/11	PRE CAT
						525 d	DIESEL	04/10	PRE CAT
						530 d	DIESEL	03/10	PRE CAT
						730 d	DIESEL	02/	PRE CAT
						3.0 d	DIESEL	03/06	PRE CAT

#OEM 13.62.779.4723 - 13.62.779.5166





* WITH DPF

EGTS SENSOR

NTC







EXHAUST GAS TEMPERATURE SENSOR ABGASTEMPÉRATURSENSOR





PRODUCT	MODEL	ENGINE	FUEL	YEAR	POSITION
9022	BMW X3				
		2.0 3.0	DIESEL DIESEL	04/ 04/	PRE CAT PRE CAT

#OEM 13.62.779.8472 - 13.62.780.9156



PRODUCT	MODEL	ENGINE	FUEL	YEAR	POSITION					
9023	BMW									
						SERIE 3	325 d 330 d 330 xd	DIESEL DIESEL DIESEL	06/11 05/12 05/12	POST CAT POST CAT POST CAT
						SERIE 5	525 xd 530 d	DIESEL DIESEL	07/10 03/10	POST CAT POST CAT
						X3	2.0 d 3.0 d	DIESEL DIESEL	04/ 04/	PRE DPF PRE DPF
						X5	3.0 d	DIESEL	07/08	POST CAT
						X6	3.0 d	DIESEL	08/	POST CAT

#OEM 13.62.779.8486 - 13.62.780.9157

PRODUCT	MODEL	ENGINE	FUEL	YEAR	POSITION					
9024	BMW									
						SERIE 5	535 d	DIESEL	04/10	PRE CAT
						SERIE 7	730 d 745 d	DIESEL DIESEL	02/ 05/05	PRE CAT PRE DPF
X3	3.0 d	DIESEL	04/	PRE CAT						

#OEM 13.62.779.5175 - 13.62.780.9155







EGTS SENSOR





NTC



EXHAUST GAS TEMPERATURE SENSOR ABGASTEMPÉRATURSENSOR

PRODUCT	MODEL	ENGINE	FUEL	YEAR	POSITION
9025	BMW				
	SERIE 3	335 d	DIESEL	06/11	POST CAT
	SERIE 7	745 d	DIESEL	05/05	PRE CAT
	X3	3.0 d	DIESEL	04/	POST CAT

#OEM 13.62.779.6850 - 13.62.780.9161

PRODUCT	MODEL	ENGINE	FUEL	YEAR	POSITION
9026	BMW				
	SERIE 3	325 d	DIESEL	06/11	PRE CAT
		330 d	DIESEL	05/11	PRE CAT
		330 xd	DIESEL	05/11	PRE CAT
	SERIE 5	520 d	DIESEL	05/10	PRE DPF
		520 d	DIESEL	05/10	PRE CAT
		525 d	DIESEL	07/10	PRE CAT
		530 d	DIESEL	07/10	PRE CAT
		535 d	DIESEL	04/10	PRE DPF
	X3	3.0 d	DIESEL	04/	PRE CAT
	X5	3.0 d	DIESEL	03/08	PRE CAT
	X6	3.0 d	DIESEL	08/	PRE CAT

#OEM 13.62.779.5174 - 13.62.780.9153

EGTS SENSOR

NTC



EXHAUST GAS TEMPERATURE SENSOR ABGASTEMPÉRATURSENSOR

PRODUCT	MODEL	ENGINE	FUEL	YEAR	POSITION
9027 	BMW				
	X5	3.0 d	DIESEL	07/08	PRE CAT
	X6	3.0 d 3.0 xDrive	DIESEL DIESEL	08/ 10/	PRE CAT PRE CAT

#OEM 13.62.780.5151 - 13.62.780.9159

PRODUCT	MODEL	ENGINE	FUEL	YEAR	POSITION
9031 	AUDI				
	A1	2.0 TDI	DIESEL	11/15	POST DPF
	SEAT				
	IBIZA IV	2.0 TDI	DIESEL	10/15	POST DPF





#OEM 03L.906.088.CP





EGTS SENSOR

NTC



EXHAUST GAS TEMPERATURE SENSOR ABGASTEMPÉRATURSENSOR

PRODUCT	MODEL	ENGINE	FUEL	YEAR	POSITION	
9032 	AUDI Q3 #OEM 03L.906.088.CL					
	VOLKSWAGEN CADDY III CADDY IV SHARAN TIGUAN TOURAN #OEM 03L.906.088.CL					
						
			2.0 TDI	DIESEL	11/18	PRE DPF
			2.0 TDI	DIESEL	12/15	PRE DPF
			2.0 TDI	DIESEL	15/	PRE DPF
			2.0 TDI	DIESEL	10/	PRE DPF





PRODUCT	MODEL	ENGINE	FUEL	YEAR	POSITION	
9038 	BMW SERIE 3 SERIE 5 SERIE 6 X3 X5 X6 #OEM 13.62.780.1159 - 13.62.780.4758					
						
			335 d	DIESEL	06/11	PRE CAT
			535 d	DIESEL	07/10	PRE CAT
			635 d	DIESEL	07/	PRE CAT
			3.0 d	DIESEL	04/	PRE CAT
			3.5 d	DIESEL	08/	PRE CAT

EGTS SENSOR

NTC







EXHAUST GAS TEMPERATURE SENSOR ABGASTEMPERATURSENSOR

PRODUCT	MODEL	ENGINE	FUEL	YEAR	POSITION
9039	BMW				
	X5	3.0 sd	DIESEL	07/09	PRE CAT
	X6	3.5 d	DIESEL	08/	PRE CAT







#OEM 13.62.780.4781 - 13.62.780.9160

PRODUCT	MODEL	ENGINE	FUEL	YEAR	POSITION
9040	BMW				
	SERIE 3	335 d	DIESEL	06/11	POST CAT
	SERIE 5	535 d	DIESEL	07/10	POST CAT
	SERIE 6	635 d	DIESEL	07/	POST CAT
	SERIE 7	745 d	DIESEL	05/	PRE CAT
	X5	3.0 sd	DIESEL	07/09	POST CAT
	X6	3.5 d	DIESEL	08/	POST CAT



#OEM 13.62.780.6251 - 13.62.780.9158

PRODUCT	MODEL	ENGINE	FUEL	YEAR	POSITION
9041	FORD				
	RANGER	2.2 TDCI 3.2 TDCI	DIESEL DIESEL	11/ 11/	POST CAT POST CAT







#OEM AB39-12B591-AA - 5217226

EGTS SENSOR





NTC



EXHAUST GAS TEMPERATURE SENSOR ABGASTEMPERATURSENSOR





PRODUCT	MODEL	ENGINE	FUEL	YEAR	POSITION
9042 	FORD				
	C-MAX II	2.0 TDCI	DIESEL	11/	PRE DPF
	RANGER	2.2 TDCI 3.2 TDCI	DIESEL DIESEL	11/ 11/	PRE DPF PRE DPF
	TRANSIT	2.2 TDCI	DIESEL	12/	PRE DPF

#OEM AV61-12B591-BA - 1706109

PRODUCT	MODEL	ENGINE	FUEL	YEAR	POSITION
9044 	FORD				
	RANGER	2.2 TDCI	DIESEL	11/	PRE DPF
	TRANSIT	2.2 TDCI	DIESEL	12/	PRE DPF

#OEM EB3G-12B591-GA - 2135322

* MANUAL TRANSMISSIONS

PRODUCT	MODEL	ENGINE	FUEL	YEAR	POSITION
9046 	FORD				
	RANGER	3.2 TDCI	DIESEL	11/	PRE CAT





#OEM EB3G-12B591-DC - 2135318

EGTS SENSOR

NTC







EXHAUST GAS TEMPERATURE SENSOR ABGASTEMPERATURSENSOR

PRODUCT	MODEL	ENGINE	FUEL	YEAR	POSITION
9049	FORD				
	RANGER	3.2 TDCI	DIESEL	11/	POST DPF





#OEM EB3G-12B591-CD - 2135320



PRODUCT	MODEL	ENGINE	FUEL	YEAR	POSITION
9051	RENAULT				
	CAPTUR I	1.5 dCi	DIESEL	13/	PRE TURBO
	FLUENCE	1.5 dCi	DIESEL	14/	PRE TURBO
	KANGOO	1.5 dCi	DIESEL	13/	PRE TURBO

#OEM 22.64.098.45R



PRODUCT	MODEL	ENGINE	FUEL	YEAR	POSITION
9052	RENAULT				
	GRAND SCÉNIC III	2.0 dCi	DIESEL	09/	PRE TURBO
	MASTER III	2.3 dCi	DIESEL	10/	PRE TURBO
	MEGANE III	2.0 dCi	DIESEL	09/	PRE TURBO
	SCÉNIC III	2.0 dCi	DIESEL	09/	PRE TURBO
	TRAFIC II	2.0 dCi	DIESEL	06/	PRE TURBO

#OEM 82.00.930.751





EGTS SENSOR

NTC



EXHAUST GAS TEMPERATURE SENSOR ABGASTEMPÉRATURSENSOR

PRODUCT	MODEL	ENGINE	FUEL	YEAR	POSITION
9056 	SEAT				
	ALHAMBRA	2.0 TDI	DIESEL	10/	PRE DPF
	EXEO	2.0 TDI	DIESEL	08/13	PRE DPF
	#OEM 03L.906.088.DK				
	VOLKSWAGEN				
CADDY III	2.0 TDI	DIESEL	12/15	PRE DPF	
#OEM 03L.906.088.ER					

PRODUCT	MODEL	ENGINE	FUEL	YEAR	POSITION
9057 	AUDI				
	A1	1.6 TDI	DIESEL	11/15	PRE TURBO
	A3	1.6 TDI 2.0 TDI 2.0 TDI 16V	DIESEL DIESEL DIESEL	09/12 03/12 03/12	PRE TURBO PRE TURBO PRE TURBO
	Q3	2.0 TDI	DIESEL	11/15	PRE TURBO
	TT	2.0 TDI	DIESEL	08/14	PRE TURBO
	#OEM 03L.906.088.AP 03L.906.088.EC				
	SEAT				
	ALTEA	1.6 TDI 2.0 TDI 16V	DIESEL DIESEL	10/ 04/	PRE TURBO PRE TURBO
	IBIZA IV	2.0 TDI	DIESEL	10/15	PRE TURBO
	LEON	1.6 TDI 2.0 TDI	DIESEL DIESEL	10/12 05/12	PRE TURBO PRE TURBO
	#OEM 03L.906.088.JG				

CONTINUING...

EGTS SENSOR

NTC



EXHAUST GAS TEMPERATURE SENSOR ABGASTEMPERATURSENSOR

PRODUCT	MODEL	ENGINE	FUEL	YEAR	POSITION
 <p>9057</p>	SKODA				
	OCTAVIA III	1.6 TDI 2.0 TDI	DIESEL DIESEL	09/13 10/13	PRE TURBO PRE TURBO
	SUPERB II	1.6 TDI 2.0 TDI 2.0 TDI 16V	DIESEL DIESEL DIESEL	10/15 08/15 10/15	PRE TURBO PRE TURBO PRE TURBO
	YETI	1.6 TDI 2.0 TDI	DIESEL DIESEL	10/15 09/17	PRE TURBO PRE TURBO
	#OEM 03L.906.088.BD				
	VOLKSWAGEN				
	BEETLE	1.6 TDI 2.0 TDI	DIESEL DIESEL	11/16 11/16	PRE TURBO PRE TURBO
	CADDY	2.0 TDI	DIESEL	15/	PRE TURBO
	CC	2.0 TDI	DIESEL	11/16	PRE TURBO
	EOS	2.0 TDI 16V	DIESEL	08/15	PRE TURBO
	GOLF PLUS V	09/13	DIESEL	05/15	PRE TURBO
	GOLF VI	1.6 TDI 2.0 TDI	DIESEL DIESEL	09/12 08/13	PRE TURBO PRE TURBO
	JETTA III	1.6 TDI 2.0 TDI	DIESEL DIESEL	09/10 05/10	PRE TURBO PRE TURBO
	JETTA IV	1.6 TDI 2.0 TDI	DIESEL DIESEL	10/15 10/	PRE TURBO PRE TURBO
	PASSAT	2.0 TDI	DIESEL	12/14	PRE TURBO
	SCIROCCO	2.0 TDI	DIESEL	10/17	PRE TURBO
	TIGUAN	2.0 TDI	DIESEL	10/18	PRE TURBO
	TOURAN	1.6 TDI 2.0 TDI	DIESEL DIESEL	10/15 10/15	PRE TURBO PRE TURBO
	XLI	0.8 TDI E-Hybrid	DIESEL	14/	PRE TURBO





#OEM 03L.906.088.AP - 03L.906.088.EC - 03L.906.088.FA





EGTS SENSOR

NTC



EXHAUST GAS TEMPERATURE SENSOR ABGASTEMPERATURSENSOR

PRODUCT	MODEL	ENGINE	FUEL	YEAR	POSITION
	9058				
	AUDI				
	A4	2.0 TDI	DIESEL	09/16	PRE DPF
	A5	2.0 TDI	DIESEL	08/17	PRE DPF
	A6	2.0 TDI	DIESEL	11/18	PRE DPF
	Q5	2.0 TDI	DIESEL	08/17	PRE DPF
	#OEM 03L.906.088.FH				
	SEAT				
	EXEO	2.0 TDI	DIESEL	08/13	PRE DPF
	EXEO ST	2.0 TDI	DIESEL	08/13	PRE DPF
#OEM 03L.906.088.FH					





PRODUCT	MODEL	ENGINE	FUEL	YEAR	POSITION
	9059				
	SEAT				
	IBIZA IV	1.4 TDI	DIESEL	15/17	PRE TURBO
	IBIZA IV ST	1.4 TDI	DIESEL	15/16	PRE TURBO
	#OEM 04L.906.088.CJ				
	SKODA				
	FABIA III	1.4 TDI	DIESEL	14/	PRE TURBO
	#OEM 04L.906.088.CJ				
	VOLKSWAGEN				
	POLO V	1.4 TDI	DIESEL	14/	PRE TURBO
#OEM 04L.906.088.CJ					

EGTS SENSOR





NTC



EXHAUST GAS TEMPERATURE SENSOR ABGASTEMPERATURSENSOR

PRODUCT	MODEL	ENGINE	FUEL	YEAR	POSITION
9060	VOLKSWAGEN				
	MULTIVAN T6	2.0 TDI	DIESEL	15/	PRE TURBO
	TRANSPORTER VI	2.0 TDI	DIESEL	15/	PRE TURBO

#OEM 04L.906.088.DF

PRODUCT	MODEL	ENGINE	FUEL	YEAR	POSITION
9061	AUDI				
	A1	1.6 TDI	DIESEL	14/18	PRE TURBO
	A3	1.6 TDI	DIESEL	12/15	PRE TURBO
	Q2	1.6 TDI	DIESEL	16/18	PRE TURBO
	Q3	2.0 TDI	DIESEL	15/18	PRE TURBO

#OEM 04L.906.088.DT

SEAT	ALHAMBRA	2.0 TDI	DIESEL	11/	PRE TURBO
	ARONA	1.6 TDI	DIESEL	17/	PRE TURBO
	ATECA	1.6 TDI	DIESEL	16/	PRE TURBO
	IBIZA V	1.6 TDI	DIESEL	17/	PRE TURBO
	LEON	1.6 TDI	DIESEL	13/	PRE TURBO
	LEON ST	1.6 TDI	DIESEL	14/	PRE TURBO
	TOLEDO IV	1.6 TDI	DIESEL	15/19	PRE TURBO

#OEM 04L.906.088.DT

CONTINUING...

EGTS SENSOR

NTC



EXHAUST GAS TEMPERATURE SENSOR ABGASTEMPERATURSENSOR

PRODUCT	MODEL	ENGINE	FUEL	YEAR	POSITION
9061 	SKODA				
	KAROQ	1.6 TDI	DIESEL	17/	PRE TURBO
	OCTAVIA IV	1.6 TDI	DIESEL	12/	PRE TURBO
	RAPID	1.6 TDI	DIESEL	15/19	PRE TURBO
	SUPERB III	1.6 TDI	DIESEL	15/	PRE TURBO
	#OEM 04L.906.088.DT				
	VOLKSWAGEN				
	CADDY	2.0 TDI	DIESEL	15/	PRE TURBO
	CC	2.0 TDI	DIESEL	15/16	PRE TURBO
	GOLF VI	2.0 TDI	DIESEL	13/16	PRE TURBO
	GOLF VII	1.6 TDI	DIESEL	16/	PRE TURBO
	PASSAT	1.6 TDI	DIESEL	14/	PRE TURBO
	SCIROCCO III	2.0 TDI	DIESEL	13/17	PRE TURBO
	SHARAN	2.0 TDI	DIESEL	15/	PRE TURBO
	TIGUAN	2.0 TDI 1.6 TDI	DIESEL DIESEL	15/18 16/20	PRE TURBO PRE TURBO
TOURAN	1.6 TDI	DIESEL	15/	PRE TURBO	
#OEM 04L.906.088.DT					

PRODUCT	MODEL	ENGINE	FUEL	YEAR	POSITION
9062 	AUDI				
	A1	1.4 TDI	DIESEL	14/18	PRE DPF
	#OEM 04L.906.088.CH				
	SEAT				
	TOLEDO IV	1.4 TDI	DIESEL	15/19	PRE DPF
IBIZA IV	1.4 TDI	DIESEL	15/17	PRE DPF	
#OEM 04L.906.088.CH					

CONTINUING...

EGTS SENSOR

NTC



EXHAUST GAS TEMPERATURE SENSOR ABGASTEMPÉRATURSENSOR

PRODUCT	MODEL	ENGINE	FUEL	YEAR	POSITION
9062 	SKODA				
	RAPID	1.6 TDI 1.4 TDI	DIESEL DIESEL	15/19 15/19	PRE DPF PRE DPF
	FABIA III	1.4 TDI	DIESEL	14/	PRE DPF
	#OEM 04L.906.088.CH				
	VOLKSWAGEN				
	POLO V	1.4 TDI	DIESEL	14/	PRE DPF
#OEM 04L.906.088.CH					

PRODUCT	MODEL	ENGINE	FUEL	YEAR	POSITION
9063 	AUDI				
	A3	2.0 TDI	DIESEL	12/	PRE DPF
	Q2	2.0 TDI	DIESEL	16/	PRE DPF
	TT	2.0 TDI	DIESEL	17/	PRE DPF
	#OEM 04L.906.088.BB				
	SEAT				
	ATECA	2.0 TDI	DIESEL	16/	PRE DPF
	LEON SC	2.0 TDI	DIESEL	13/	PRE DPF
	LEON ST	2.0 TDI	DIESEL	14/	PRE DPF
	#OEM 04L.906.088.JE				
	SKODA				
	KAROQ	2.0 TDI	DIESEL	17/	PRE DPF
OCTAVIA III	2.0 TDI	DIESEL	12/	PRE DPF	
SUPERB III	2.0 TDI	DIESEL	15/	PRE DPF	
#OEM 04L.906.088.JE					

CONTINUING...

EGTS SENSOR

NTC



EXHAUST GAS TEMPERATURE SENSOR ABGASTEMPÉRATURSENSOR

PRODUCT	MODEL	ENGINE	FUEL	YEAR	POSITION
9063 	VOLKSWAGEN				
	ARTEON	2.0 TDI	DIESEL	17/20	PRE DPF
	GOLF VII	2.0 GTD, 2.0 TDI	DIESEL	13/	PRE DPF
	PASSAT B8	2.0 TDI	DIESEL	14/	PRE DPF
	T-ROC	2.0 TDI	DIESEL	17/	PRE DPF
#OEM 04L.906.088.BB					

PRODUCT	MODEL	ENGINE	FUEL	YEAR	POSITION	
9064 	AUDI					
	A3	2.0 TDI	DIESEL	12/	PRE CAT	
	Q2	2.0 TDI	DIESEL	16/	PRE CAT	
	TT	2.0 TDI	DIESEL	14/	PRE CAT	
	#OEM 04L.906.088.AC 04L.906.088.BL					
	SEAT					
	ATECA	2.0 TDI	DIESEL	16/	PRE CAT	
	LEON ST	2.0 TDI	DIESEL	14/	PRE CAT	
	#OEM 04L.906.088.AC					
	SKODA					
KAROQ	2.0 TDI	DIESEL	17/	PRE CAT		
OCTAVIA III	2.0 TDI	DIESEL	12/	PRE CAT		
SUPERB III	2.0 TDI	DIESEL	15/	PRE CAT		
#OEM 04L.906.088.BL						





CONTINUING...

EGTS SENSOR





NTC



EXHAUST GAS TEMPERATURE SENSOR ABGASTEMPERATURSENSOR

PRODUCT	MODEL	ENGINE	FUEL	YEAR	POSITION
9064 	VOLKSWAGEN				
	ARTEON	2.0 TDI	DIESEL	17/20	PRE CAT
	CADDY IV	2.0 TDI	DIESEL	15/	PRE CAT
	GOLF VII	2.0 GTD, 2.0 TDI	DIESEL	12/	PRE CAT
	PASSAT B8	2.0 TDI	DIESEL	14/	PRE CAT
	T-ROC	2.0 TDI	DIESEL	17/	PRE CAT

#OEM 04L.906.088.AC - 04L.906.088.BL

PRODUCT	MODEL	ENGINE	FUEL	YEAR	POSITION	
9065 	AUDI					
	A3	2.0 TDI	DIESEL	15/	PRE DPF	
	Q2	2.0 TDI	DIESEL	16/	PRE DPF	
	TT	2.0 TDI	DIESEL	17/	PRE DPF	
	#OEM 04L.906.088.DB					
	SEAT					
	LEON ST	2.0 TDI	DIESEL	15/	PRE DPF	
	LEON SC	2.0 TDI	DIESEL	15/	PRE DPF	
	#OEM 04L.906.088.DB					
	SKODA					
	OCTAVIA III	2.0 TDI	DIESEL	12/	PRE DPF	
	#OEM 04L.906.088.DB					
VOLKSWAGEN						
PASSAT B8	2.0 TDI	DIESEL	14/	PRE DPF		
GOLF VII	2.0 GTD, 2.0 TDI	DIESEL	13/	PRE DPF		

#OEM 04L.906.088.DB

EGTS SENSOR

NTC



EXHAUST GAS TEMPERATURE SENSOR ABGASTEMPERATURSENSOR

PRODUCT	MODEL	ENGINE	FUEL	YEAR	POSITION
9066 	VOLKSWAGEN				
	CARAVELLE	2.0 TDI	DIESEL	15/	PRE CAT
	MULTIVAN T6	2.0 TDI	DIESEL	15/	PRE CAT
	TRANSPORTER	2.0 TDI	DIESEL	15/	PRE CAT
#OEM 04L.906.088.DC					

PRODUCT	MODEL	ENGINE	FUEL	YEAR	POSITION
9067 	VOLKSWAGEN				
	CADDY ALLTRACK	2.0 TDI	DIESEL	15/	PRE DPF
	CADDY IV	2.0 TDI	DIESEL	15/15	PRE DPF
	CARAVELLE	2.0 TDI	DIESEL	16/	PRE DPF
	MULTIVAN T6	2.0 TDI	DIESEL	15/	PRE DPF
	TRANSPORTER	2.0 TDI	DIESEL	16/	PRE DPF
#OEM 04L.906.088.DD					





PRODUCT	MODEL	ENGINE	FUEL	YEAR	POSITION
9068 	VOLKSWAGEN				
	CARAVELLE	2.0 TDI	DIESEL	16/	POST DPF
	MULTIVAN T6	2.0 TDI	DIESEL	15/	POST DPF
	TRANSPORTER	2.0 TDI	DIESEL	16/	POST DPF
#OEM 04L.906.088.DE					





EGTS SENSOR





NTC



EXHAUST GAS TEMPERATURE SENSOR ABGASTEMPERATURSENSOR

PRODUCT	MODEL	ENGINE	FUEL	YEAR	POSITION
 <p>9069</p>	VOLKSWAGEN				
	CADDY ALLTRACK	2.0 TDI	DIESEL	15/	PRE CAT
	CADDY IV	2.0 TDI	DIESEL	15/15	PRE CAT
	CC B7	2.0 TDI	DIESEL	15/16	PRE CAT
	SCIROCCO III	2.0 TDI	DIESEL	14/17	PRE CAT
#OEM 04L.906.088.DJ					

PRODUCT	MODEL	ENGINE	FUEL	YEAR	POSITION
 <p>9070</p>	AUDI				
	A4 B8	2.0 TDI	DIESEL	09/16	POST DPF
	A5	2.0 TDI	DIESEL	08/17	POST DPF
	A6 C7	2.0 TDI	DIESEL	11/18	POST DPF
	Q5	2.0 TDI	DIESEL	08/17	POST DPF
#OEM 03L.906.088.HA					
*AUTOMATIC - CVT AUTOMATIC					

PRODUCT	MODEL	ENGINE	FUEL	YEAR	POSITION
 <p>9071</p>	AUDI				
	Q2	2.0 TDI	DIESEL	16/	POST DPF
	#OEM 04L.906.088.EC				
	SEAT				
ATECA	2.0 TDI	DIESEL	16/	POST DPF	
#OEM 04L.906.088.EC					

CONTINUING...

EGTS SENSOR

NTC



EXHAUST GAS TEMPERATURE SENSOR ABGASTEMPÉRATURSENSOR

PRODUCT	MODEL	ENGINE	FUEL	YEAR	POSITION
 <p>9071</p>	SKODA				
	SUPERB III	2.0 TDI	DIESEL	15/	POST DPF
	#OEM 04L.906.088.EC				
	VOLKSWAGEN				
	ARTEON	2.0 TDI	DIESEL	17/20	POST DPF
PASSAT B8	2.0 TDI	DIESEL	14/	POST DPF	
#OEM 04L.906.088.EC					

PRODUCT	MODEL	ENGINE	FUEL	YEAR	POSITION
 <p>9076</p>	FORD				
	F-250 Super Duty	6.4	DIESEL	08/10	PRE TURBO
	F-350 Super Duty	6.4	DIESEL	08/10	PRE TURBO
	F-450 Super Duty	6.4	DIESEL	08/10	PRE TURBO
	F-550 Super Duty	6.4	DIESEL	08/10	PRE TURBO

#OEM 8C3Z-12B591-E - 8C3Z-12B591-B

EGTS SENSOR

NTC



EXHAUST GAS TEMPERATURE SENSOR ABGASTEMPERATURSENSOR

CROSS REFERENCE

OEM	# OEM	# MTE-THOMSON
-----	-------	---------------

AUDI

03L.906.088 HA **9070**

BMW

13.62.779.4723 **9020**

13.62.779.5166 **9021**

13.62.779.5174 **9026**

13.62.779.5175 **9024**

13.62.779.6850 **9025**

13.62.779.8472 **9022**

13.62.779.8486 **9023**

13.62.780.1159 **9038**

13.62.780.4758 **9038**

13.62.780.4781 **9039**

13.62.780.5151 **9027**

13.62.780.6251 **9040**

13.62.780.6254 **9020**

13.62.780.9153 **9026**

13.62.780.9155 **9024**

13.62.780.9156 **9022**

13.62.780.9157 **9023**

13.62.780.9158 **9040**

13.62.780.9159 **9027**

13.62.780.9160 **9039**

13.62.780.9161 **9025**

FORD

1381181 **9002**

1406177 **9001**

1455174 **9003**

1480867 **9002**

1496243 **9003**

1508575 **9004**

1543768 **9002**

1706109 **9042**

2135318 **9046**

EGTS SENSOR

NTC



EXHAUST GAS TEMPERATURE SENSOR ABGASTEMPERATURSENSOR

CROSS REFERENCE

OEM	# OEM	# MTE-THOMSON
FORD	2135320	9049
	2135322	9044
	5217226	9041
	6G91-12B591-DA	9001
	6S71-12B591-BA	9002
	6S71-12B591-C	9001
	8C11-12B591-CA	9003
	8C3Z-12B591-E	9076
	8V41-12B591-BA	9004
	9V41-12B591-AA	9002
	AB39-12B591-AA	9041
	AG91-12B591-AA	9005
	AV61-12B591-BA	9042
	EB3G-12B591-CD	9049
	EB3G-12B591-DC	9046
EB3G-12B591-GA	9044	
NISSAN	22365-00QAF	9009
OPEL	4433537	9006
	93198108	9006
RENAULT	22.64.052.22R	9011
	22.64.052.27R	9011
	22.64.098.45R	9051
	82.00.014.126	9010
	82.00.513.321	9007
	82.00.626.456	9007
	82.00.629.249	9006
	82.00.640.532	9009
	82.00.670.145	9010
	82.00.673.215	9006
82.00.689.052	9010	

EGTS SENSOR

NTC



EXHAUST GAS TEMPERATURE SENSOR ABGASTEMPERATURSENSOR

CROSS REFERENCE

OEM

OEM

MTE-THOMSON

RENAULT

82.00.773.560	9010
82.00.872.039	9008
82.00.882.195	9009
82.00.897.221	9007
82.00.921.749	9011
82.00.929.533	9008
82.00.930.751	9052
82.00.941.746	9009

VOLKSWAGEN

032.906.088.BJ	9013
03L.906.088.A	9016
03L.906.088.AP	9057
03L.906.088.BD	9057
03L.906.088.BH	9012
03L.906.088.BK	9017
03L.906.088.CJ	9014
03L.906.088.CP	9031
03L.906.088.DK	9056
03L.906.088.EC	9057
03L.906.088.ER	9056
03L.906.088.FA	9057
03L.906.088.FA	9032
03L.906.088.FH	9058
03L.906.088.JG	9057
04L.906.088.AC	9064
04L.906.088.BB	9063
04L.906.088.BL	9064
04L.906.088.CH	9062
04L.906.088.CJ	9059
04L.906.088.DB	9065
04L.906.088.DC	9066
04L.906.088.DD	9067
04L.906.088.DE	9068

EGTS SENSOR

NTC



EXHAUST GAS TEMPERATURE SENSOR ABGASTEMPERATUR

OEM

OEM

MTE-THOMSON

CROSS

REFERENCE

VOLKSWAGEN

04L.906.088.DF	9060
04L.906.088.DJ	9069
04L.906.088.DT	9061
04L.906.088.EC	9071
04L.906.088.JE	9063
070.906.088.AG	9015

VOLVO

30777344	9001
----------	-------------





MTE-THOMSON IND. E COM. LTDA.

AVENIDA MOINHO FABRINI, 1033
CEP 09862-900
SÃO BERNARDO DO CAMPO SP BRASIL
PHONE: (55) (11) 4393 4343
FAX: (55) (11) 4393 4361
mte@mte-thomson.com.br
www.mte-thomson.com.br

Cooling and
Engine Management
Competence

MTE-THOMSON INC. - USA DIVISION

35 SW 12TH AVE - BLDG #35 SUITE 112
DANIA BEACH - FL 33004
PHONE: (1) (954) 564-5955
FAX: (1) (954) 564-5988
noto@mte-thomson.com.br
www.mte-thomson.com

MTE-THOMSON EUROPE

ARSTERDAMM, 82
28277 - BREMEN - GERMANY
PHONE: (49) (0) 421 875027
FAX: (49) (0) 421 876422
stevan.manzan@mte-thomson.com.br
www.mte-thomson.de

CatE-MTE
WEB CATALOG

CERTIFIED

TecDoc®
DATA SUPPLIER



BRAZIL - COPYRIGHT © 2019 MTE-THOMSON
3rd EDITION - 08/2021

