

EGTS



EXHAUST GAS TEMPERATURE SENSOR

ABGASTEMPERSORSOR

PT200



2021

15th EDITION



www.mte-thomson.com.br

TECHNICAL INFORMATION

10, 11, 12

PRODUCTS

9500	ALFA ROMEO - FIAT	13
9501	MERCEDES-BENZ	13
9502	MERCEDES-BENZ	13, 14
9503	OPEL	14
9504	AUDI - SEAT - SKODA - VOLKSWAGEN	14, 15
9505	AUDI - SEAT - SKODA - VOLKSWAGEN	15, 16
9506	AUDI - SEAT - SKODA - VOLKSWAGEN	17
9507	VOLKSWAGEN	18
9508	AUDI - VOLKSWAGEN	18
9509	VOLVO	19
9510	VOLKSWAGEN	19
9511	VOLKSWAGEN	19
9512	VOLKSWAGEN	20
9513	MERCEDES-BENZ	20
9514	AUDI - SEAT - SKODA - VOLKSWAGEN	20, 21
9515	AUDI - SEAT	22
9516	VOLKSWAGEN	22
9517	MERCEDES-BENZ	22
9518	MERCEDES-BENZ	23
9519	AUDI - SEAT	23
9520	AUDI - SEAT - SKODA - VOLKSWAGEN	24
9521	AUDI	24
9522	VOLVO	25
9523	GM-CHEVROLET - GMC	25
9524	GM-CHEVROLET - GMC	26
9525	MERCEDES-BENZ	26
9526	MERCEDES-BENZ	27
9527	MERCEDES-BENZ	27
9528	MERCEDES-BENZ	28
9529	MERCEDES-BENZ	28
9530	MERCEDES-BENZ	28
9531	MERCEDES-BENZ	29
9532	MERCEDES-BENZ	30
9533	MERCEDES-BENZ	30
9534	SEAT - SKODA - VOLKSWAGEN	31
9535	AUDI - VOLKSWAGEN	31



PRODUCTS

9536	MERCEDES-BENZ	32
9537	MERCEDES-BENZ	32
9538	AUDI - VOLKSWAGEN	32, 33
9539	AUDI - VOLKSWAGEN	33
9540	AUDI	34
9541	VOLKSWAGEN	34
9542	AUDI - SEAT - SKODA - VOLKSWAGEN	35
9543	VOLKSWAGEN	36
9544	VOLKSWAGEN	36
9545	PORSCHE - VOLKSWAGEN	36
9546	VOLKSWAGEN	37
9547	VOLKSWAGEN	37
9548	VOLKSWAGEN	37
9549	GM-CHEVROLET - GMC	38
9550	FORD	38
9551	ALFA ROMEO - FIAT	39
9552	MERCEDES-BENZ	39
9553	MERCEDES-BENZ	40
9554	MERCEDES-BENZ	41
9555	OPEL	41
9556	MERCEDES-BENZ	41
9557	VOLKSWAGEN	41
9558	AUDI	42
9559	AUDI	42
9561	VOLKSWAGEN	43
9562	SEAT - VOLKSWAGEN	43
9563	MERCEDES-BENZ	44
9564	OPEL	44
9565	ALFA ROMEO - FIAT - LANCIA - OPEL - VAUXHALL ..	45
9566	AUDI	46
9567	VOLKSWAGEN	46
9568	AUDI - VOLKSWAGEN	46
9569	VOLKSWAGEN	47
9570	VOLKSWAGEN	47
9571	FIAT	47
9572	VOLKSWAGEN	48
9573	SEAT - SKODA - VOLKSWAGEN	48
9574	AUDI	49



PRODUCTS

9575	AUDI	49
9576	FIAT	49
9577	GM-CHEVROLET - VAUXHALL	50
9578	GM-CHEVROLET - GMC	50
9579	VOLKSWAGEN	51
9580	AUDI - VOLKSWAGEN	51
9581	VOLKSWAGEN	52
9582	VOLKSWAGEN	52
9583	AUDI - VOLKSWAGEN	52
9584	FORD	53
9585	OPEL - VAUXHALL	53
9586	SEAT - SKODA - VOLKSWAGEN	54
9587	AUDI - VOLKSWAGEN	54, 55
9588	AUDI - SEAT - SKODA - VOLKSWAGEN	55
9589	AUDI - VOLKSWAGEN	56
9590	MERCEDES-BENZ	56
9591	AUDI - VOLKSWAGEN	57
9592	MERCEDES-BENZ	57
9593	GM-CHEVROLET - GMC	57
9594	PORSCHE - VOLKSWAGEN	58
9595	VOLKSWAGEN	58
9596	AUDI - VOLKSWAGEN	58
9597	AUDI - SEAT - SKODA - VOLKSWAGEN	59, 60
9598	AUDI - VOLKSWAGEN	60
9599	VOLKSWAGEN	61
9600	SEAT - SKODA - VOLKSWAGEN	61
9601	SEAT - SKODA - VOLKSWAGEN	62
9602	VOLKSWAGEN	62
9603	AUDI - SEAT - VOLKSWAGEN	63
9604	VOLVO	63
9605	AUDI - SEAT - SKODA - VOLKSWAGEN	64
9606	AUDI	64
9607	AUDI - SKODA	65
9608	SEAT - SKODA - VOLKSWAGEN	65
9609	SEAT - SKODA - VOLKSWAGEN	66
9610	VOLKSWAGEN	66
9611	AUDI	67
9612	VOLKSWAGEN	67



PRODUCTS

9613	MERCEDES-BENZ	67, 67
9614	MERCEDES-BENZ	68
9615	VOLKSWAGEN	69
9616	VOLKSWAGEN	69
9618	AUDI - SEAT - SKODA - VOLKSWAGEN	69, 70
9619	VOLKSWAGEN	70
9620	VOLKSWAGEN	71
9621	VOLKSWAGEN	71
9622	VOLKSWAGEN	71
9623	VOLKSWAGEN	72
9624	VOLKSWAGEN	72
9625	VOLKSWAGEN	72
9626	VOLKSWAGEN	73
9627	VOLKSWAGEN	73
9628	SEAT - VOLKSWAGEN	73
9629	AUDI	74
9630	AUDI	74
9631	AUDI - SKODA - VOLKSWAGEN	75
9632	SKODA - VOLKSWAGEN	75
9633	SKODA - VOLKSWAGEN	76
9634	AUDI - VOLKSWAGEN	76
9635	AUDI	77
9636	AUDI	77
9637	AUDI	77
9638	AUDI - SEAT - SKODA - VOLKSWAGEN	78
9639	MERCEDES-BENZ	79
9640	MERCEDES-BENZ	79
9641	MERCEDES-BENZ	80
9642	MERCEDES-BENZ	80
9643	MERCEDES-BENZ	81
9644	MERCEDES-BENZ	81
9645	OPEL	82
9646	FIAT	82
9647	OPEL	82
9648	FIAT - LANCIA	83
9649	VOLKSWAGEN	83
9650	MERCEDES-BENZ	84
9651	MERCEDES-BENZ	84



PRODUCTS

9652	MERCEDES-BENZ	85
9653	VOLKSWAGEN	85
9654	VOLKSWAGEN	85
9655	AUDI	86
9656	AUDI	86
9657	AUDI	86
9658	MERCEDES-BENZ	87
9659	VOLKSWAGEN	87
9660	VOLKSWAGEN	87
9661	MERCEDES-BENZ	88
9662	MERCEDES-BENZ	88
9663	VOLKSWAGEN	88
9664	AUDI	89
9665	FORD	89
9666	RENAULT TRUCKS - VOLVO	89, 90
9667	MERCEDES-BENZ	90
9668	RENAULT TRUCKS - VOLVO	91
9669	MERCEDES-BENZ	91
9671	MERCEDES-BENZ	92
9672	MERCEDES-BENZ	92
9673	FORD	92
9674	VOLKSWAGEN	93
9675	FORD	93
9676	FIAT - IVECO	94
9677	SMART	94
9678	AUDI	95
9679	AUDI	95
9680	PORSCHE - VOLKSWAGEN	95
9681	VOLKSWAGEN	96
9682	AUDI	96
9683	NAVISTAR	96
9684	NAVISTAR	97
9685	NAVISTAR	97
9686	FORD	97
9687	MERCEDES-BENZ	98
9688	OPEL - SAAB - VAUXHALL	98
9690	GM-CHEVROLET - OPEL - VAUXHALL	99
9691	GM-CHEVROLET - OPEL	99



PRODUCTS

9692	AUDI	100
9693	OPEL	100
9694	IVECO	100
9695	MERCEDES-BENZ	101
9696	MERCEDES-BENZ	101
9697	MERCEDES-BENZ	102
9698	VOLVO	102
9699	RENAULT - VOLVO	102, 103
96000	VOLVO	103
96001	OPEL	103
96002	FIAT - LANCIA - OPEL	104
96003	DAF	104
96004	DAF	105
96005	GM-CHEVROLET - OPEL	105
96006	OPEL	105
96007	IVECO	106
96008	FIAT	106
96009	AUDI	106
96010	AUDI	107
96011	AUDI	107
96013	AUDI - VOLKSWAGEN	107
96014	MERCEDES-BENZ	108
96015	SEAT - VOLKSWAGEN	108
96016	GM-CHEVROLET - OPEL - VAUXHALL	109
96017	ALFA ROMEO	109
96018	VOLVO	110
96019	AUDI - VOLKSWAGEN	110
96020	VOLVO	111
96021	VOLVO	111
96022	OPEL	112
96023	SCANIA	112
96024	VOLVO	112, 113
96025	NAVISTAR	113
96026	VOLKSWAGEN	113
96027	FIAT	114
96028	ALFA ROMEO - FIAT - SUZUKI	114
96029	FIAT	115
96030	ALFA ROMEO - LANCIA	115



PRODUCTS

96031	FIAT - LANCIA	116
96032	FIAT	116
96033	OPEL - VAUXHALL	117
96034	GM-CHEVROLET - OPEL	117
96035	MERCEDES-BENZ	118
96036	ALFA ROMEO - FIAT - JEEP - OPEL	118, 119
96037	OPEL	119
96038	GM-CHEVROLET - OPEL - VAUXHALL	119, 120
96039	GM-CHEVROLET	120
96040	OPEL	120
96041	OPEL	121
96042	OPEL	121
96043	GM-CHEVROLET - OPEL	121
96044	OPEL	122
96045	AUDI	122
96046	AUDI	122
96047	GM-CHEVROLET	123
96048	GM-CHEVROLET	123
96049	AUDI	123
96050	FORD	124
96051	VOLKSWAGEN	124
96052	VOLKSWAGEN	124
96053	AUDI - SEAT - SKODA - VOLKSWAGEN	125
96054	AUDI - SEAT - SKODA - VOLKSWAGEN	126
96055	AUDI - SEAT - SKODA - VOLKSWAGEN	126, 127
96056	AUDI - SEAT - SKODA - VOLKSWAGEN	128
96057	VOLKSWAGEN	129
96058	AUDI - SEAT - VOLKSWAGEN	129
96059	VOLKSWAGEN	130

CROSS REFERENCE

131, 132, 133, 134, 135, 136, 137
138, 139, 140, 141, 142, 143, 144



EGTS SENSOR

PT200



EXHAUST GAS TEMPERATURE SENSOR ABGASTEMPERATUR



An **Exhaust Gas Temperature Sensor (EGTS)** detects exhaust gas temperature, converts it into a voltage and feeds that voltage signal back to the engine **ECU**, in order to control engine conditions and effectively reduce emissions.

Exhaust Gas Temperature Sensors (EGTS) are located:

- **T3** – before the Turbocharger (**TBC**).
- **T4** – after the Turbocharger (**TBC**).
- **T5** – before/after Diesel Oxidation Catalyst (**DOC**).
- **T6** – before/after Diesel Particulate Filter (**DPF**) and Selective Catalytic Reduction (**SCR**).
- **TEGR** – before/after High-Pressure EGR Cooling System.



Exhaust Gas Temperature Measurement Points - Diesel

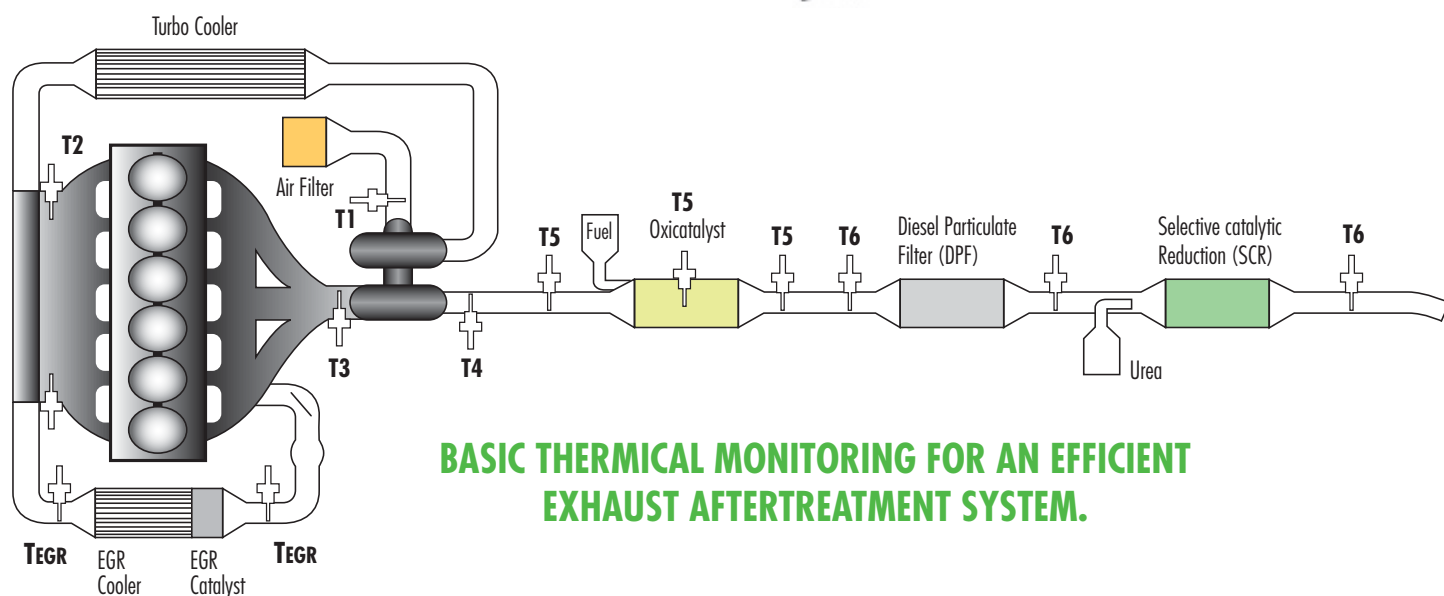

BASIC THERMAL MONITORING FOR AN EFFICIENT EXHAUST AFTERTREATMENT SYSTEM.

With the assistance of the different **EGTS** signals, the exhaust gas treatment devices can operate in their optimal conditions and their functionalities are constantly verified (**OBD – On-Board Diagnostics**).

For instance:

- The Temperature Probes before and after the Turbocharger are used to verify whether a temperature decrease (aprox. 150°C) occurred.
- The **DOC** and the **SCR** need to achieve a minimum operation temperature, respectively 140°C and 190°C.
- The Temperatures before the Turbocharger, after the **DPF** and in the **DOC** are also monitored in order to avoid overheating of these components.
- The performances of the temperatures after and before the **DPF** (together with the Differential Pressure Sensor's signal) are used to verify a successful regeneration of that component.

EGTS SENSOR

PT200



EXHAUST GAS TEMPERATURE SENSOR ABGASTEMPERATUR

TECHNOLOGIES:

MTE-THOMSON manufactures two different technologies of EGTS, NTC Thermistor and PT200. This way we can offer a complete range in the aftermarket.

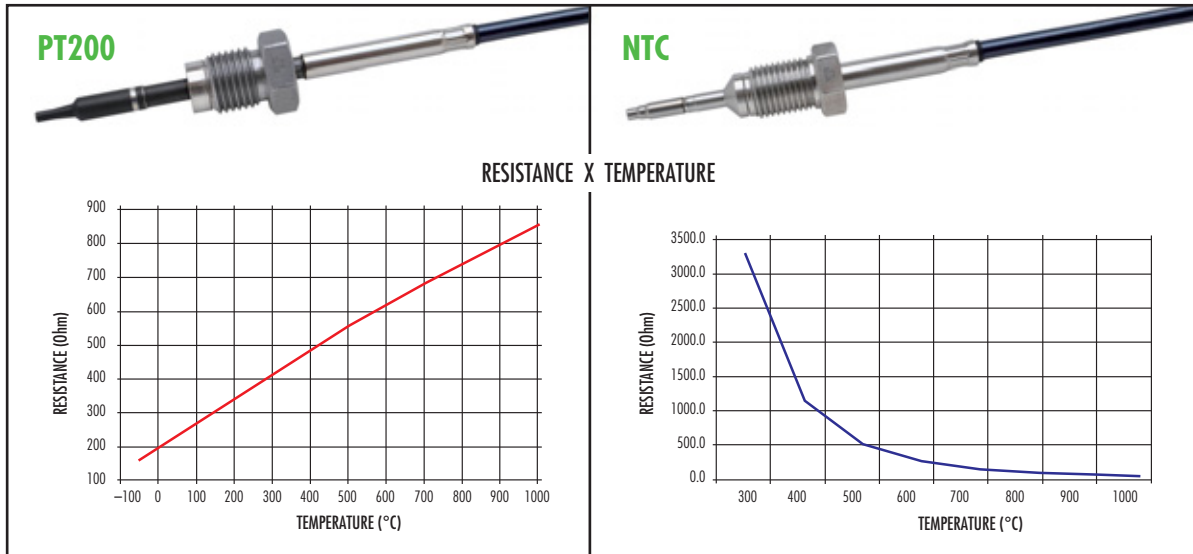

APPLICATION:

The signal is measured using a Voltage-Divider. Most ECUs use a 2.2 kOhms pull-up resistor.

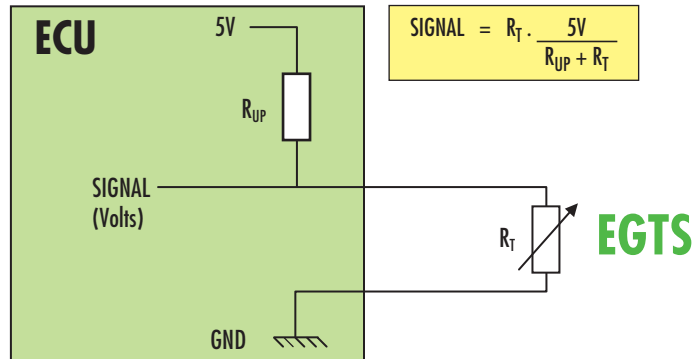

SIGNALS: PT200 x NTC

A comparison between the signals of a NTC and a Pt200 EGTS can be seen below. In this example it was used a pull-up resistor of 1000 Ohms and a 5V voltage supply.

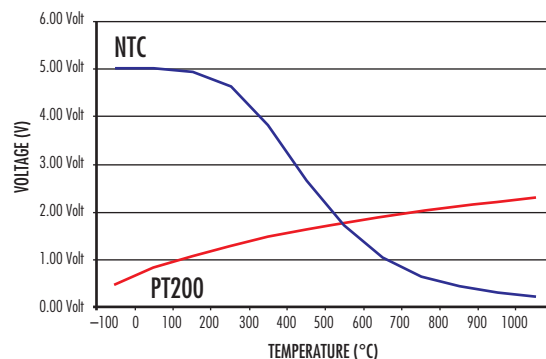

COMPONENTS:

- **Closed Stainless Cover:** Protects the sensor element against corrosion atmosphere and water drops from the exhaust.
- **NTC Thermistor:** Negative Temperature Coefficient ceramic element.
- **PT200:** Platinum element with Positive Temperature Coefficient, which has a resistance of 200 Ohms at 0°C.
- **MIC:** Mineral Isolated Cable that separates the hot part from the cold part.
- **Wires:** Teflon insulated – oil, gas and water resistant. Stranded wire – Greater flexibility
- **Connectors:** PA+GF. OEM Quality

MALFUNCTION:

Malfunctions of the Temperature Probes can lead to:

- Unnecessary filter regeneration, leading to a reduction in the filter's lifespan;
- Power losses if the sensor is not detecting the filter saturation level;
- Dashboard light for Particulate Filter and blinking light pre-heating;
- Deterioration of Turbocharger, DOC, SCR components and DPF;
- Increase in oil consumption;
- Increase in emission levels of CO, NOx and HC.

QUALITY

The EGTS from MTE-THOMSON is produced with the best raw materials, with automated processes and is tested 100% with OEM expertise.

GUARANTEE

All MTE-THOMSON products are guaranteed for 01 (one) year against defects from faulty materials or fabrication. The guarantee is limited to the replacement of the faulty part; we cannot extend the guarantee to cover defects caused by misuse, neglect, accident or wear, and tear. We cannot accept liability for consequential loss or damage which is claimed to have resulted from the use of one of our products.

More information: www.mte-thomson.com.br













EGTS SENSOR





PT200



EXHAUST GAS TEMPERATURE SENSOR ABGASTEMPERATUR

PRODUCT	MODEL	ENGINE	FUEL	YEAR	POSITION
	9500				
	ALFA ROMEO				
	MITO	1.3 Multijet	DIESEL	08/	POST CAT
	#OEM 55204765				
FIAT					
GRANDE PUNTO	1.3 Multijet	DIESEL	05/	POST CAT	
#OEM 55204765					

PRODUCT	MODEL	ENGINE	FUEL	YEAR	POSITION
	9501				
	MERCEDES-BENZ				
	C-CLASS	C200 CDI C220 CDI	DIESEL DIESEL	07/12 07/08	PRE DPF PRE DPF
	S-CLASS	S350 Bluetec	DIESEL	11/	PRE DPF
#OEM 001.905.30.00					

PRODUCT	MODEL	ENGINE	FUEL	YEAR	POSITION
	9502				
	MERCEDES-BENZ				
	E-CLASS	E200 CDI E220 CDI E280 CDI E320 CDI E220 T CDI E280 T CDI E320 T CDI	DIESEL DIESEL DIESEL DIESEL DIESEL DIESEL DIESEL	02/08 02/08 04/08 02/08 06/09 04/09 03/09	POST DPF POST DPF POST DPF POST DPF POST DPF POST DPF POST DPF
	S-CLASS	S350 Bluetec	DIESEL	11/	POST DPF
#OEM 007 153 75 28 - 000.905.40.05					

CONTINUING...

EGTS SENSOR

PT200



EXHAUST GAS TEMPERATURE SENSOR ABGASTEMPERATUR

PRODUCT	MODEL	ENGINE	FUEL	YEAR	POSITION				
9502	MERCEDES-BENZ R-CLASS								
						R280 CDI	DIESEL	06/	POST DPF
						R300 CDI	DIESEL	09/	POST DPF
						R320 CDI	DIESEL	06/	POST DPF
SPRINTER 3,5t	316CDI 318CDI								
						316CDI	DIESEL	09/	PRE CAT/DPF
SPRINTER 4,6t	415CDI								
						415CDI	DIESEL	08/	PRE CAT/DPF
		415CDI	DIESEL	06/	POST DPF				

#OEM 007 153 75 28 - 000.905.40.05

PRODUCT	MODEL	ENGINE	FUEL	YEAR	POSITION				
9503	OPEL ASTRA J CORSA D								
						1.3 CDTI	DIESEL	09/	PRE CAT
						1.3 CDTI	DIESEL	06/	PRE CAT

#OEM 855457 - 55564977

PRODUCT	MODEL	ENGINE	FUEL	YEAR	POSITION				
9504	AUDI A3								
						1.6 TDI	DIESEL	09/12	POST DPF
						2.0 TDI	DIESEL	03/12	POST DPF
						2.0 TDI 16V	DIESEL	03/12	POST DPF

#OEM 03L 906 088 CC

CONTINUING...

EGTS SENSOR

PT200



EXHAUST GAS TEMPERATURE SENSOR ABGASTEMPERATUR

PRODUCT	MODEL	ENGINE	FUEL	YEAR	POSITION
 <p>9504</p>	SEAT				
	ALTEA	1.6 TDI 2.0 TDI	DIESEL DIESEL	10/ 06/	POST DPF POST DPF
	LEON	1.6 TDI 2.0 TDI	DIESEL DIESEL	10/12 06/12	POST DPF POST DPF
	#OEM 03L 906 088 CC				
	SKODA				
	OCTAVIA	1.6 TDI 2.0 TDI RS	DIESEL DIESEL	09/13 06/13	POST DPF POST DPF
	SUPERCAB	1.6 TDI 2.0 TDI	DIESEL DIESEL	10/15 08/15	POST DPF POST DPF
	YETI	1.6 TDI 2.0 TDI	DIESEL DIESEL	10/ 09/	POST DPF POST DPF
	#OEM 03L 906 088 CC				
	VOLKSWAGEN				
GOLF VI	1.6 TDI 2.0 TDI	DIESEL DIESEL	09/12 08/12	POST DPF POST DPF	
GOLF PLUS	2.0 TDI	DIESEL	05/13	POST DPF	
#OEM 03L 906 088 CC					

PRODUCT	MODEL	ENGINE	FUEL	YEAR	POSITION
 <p>9505</p>	AUDI				
	A3	1.6 TDI 2.0 TDI 2.0 TDI 16V	DIESEL DIESEL DIESEL	09/12 03/12 03/12	PRE DPF PRE DPF PRE DPF
	TT	2.0 TDI	DIESEL	08/14	PRE DPF
#OEM 03L 906 088AJ					

CONTINUING...

EGTS SENSOR

PT200



EXHAUST GAS TEMPERATURE SENSOR ABGASTEMPERATUR

PRODUCT	MODEL	ENGINE	FUEL	YEAR	POSITION
 <p>9505</p>	SEAT				
	ALTEA	1.6 TDI 2.0 TDI	DIESEL DIESEL	10/ 07/	PRE DPF PRE DPF
	LEON	1.6 TDI 2.0 TDI	DIESEL DIESEL	10/12 06/12	PRE DPF PRE DPF
	#OEM 03L 906 088AJ				
	SKODA				
	OCTAVIA	1.6 TDI 2.0 TDI RS	DIESEL DIESEL	09/13 06/13	PRE DPF PRE DPF
	SUPERCAB	1.6 TDI 2.0 TDI	DIESEL DIESEL	10/15 08/15	PRE DPF PRE DPF
	YETI	1.6 TDI 2.0 TDI	DIESEL DIESEL	10/ 09/	PRE DPF PRE DPF
	#OEM 03L 906 088AJ				
	VOLKSWAGEN				
	BEETLE	1.6 TDI	DIESEL	11/	PRE DPF
	EOS	2.0 TDI 16V	DIESEL	08/	PRE DPF
	GOLF V	2.0 TDI	DIESEL	03/08	PRE DPF
	GOLF VI	1.6 TDI 2.0 TDI	DIESEL DIESEL	09/12 08/13	PRE DPF PRE DPF
	GOLF PLUS	1.6 TDI 2.0 TDI 2.0 TDI 16V	DIESEL DIESEL DIESEL	09/13 09/13 05/13	PRE DPF PRE DPF PRE DPF
	JETTA III	1.6 TDI 2.0 TDI 2.0 TDI 16V	DIESEL DIESEL DIESEL	09/10 05/10 05/10	PRE DPF PRE DPF PRE DPF
	JETTA IV	1.6 TDI	DIESEL	11/	PRE DPF
	PASSAT	1.6 TDI 2.0 TDI 2.0 TDI 16V 2.0 BlueTDI	DIESEL DIESEL DIESEL DIESEL	09/14 08/14 05/10 09/10	PRE DPF PRE DPF PRE DPF PRE DPF
	PASSAT CC	2.0 TDI	DIESEL	08/12	PRE DPF
	SCIROCCO	2.0 TDI	DIESEL	08/	PRE DPF

#OEM 03L 906 088AJ

EGTS SENSOR

PT200



EXHAUST GAS TEMPERATURE SENSOR ABGASTEMPERATUR

PRODUCT	MODEL	ENGINE	FUEL	YEAR	POSITION
 <p>9506</p>	AUDI				
	A3	1.9 TDI 2.0 TDI	DIESEL DIESEL	03/10 05/13	POST DPF POST DPF
	TT	2.0 TDI	DIESEL	08/14	POST DPF
	#OEM 03G 906 088 D				
	SEAT				
	ALTEA	1.9 TDI 2.0 TDI 2.0 TDI 16V	DIESEL DIESEL DIESEL	05/ 06/ 10/	POST DPF POST DPF POST DPF
	LEON	1.9 TDI 2.0 TDI	DIESEL DIESEL	05/10 05/12	POST DPF POST DPF
	TOLEDO III	1.9 TDI 2.0 TDI	DIESEL DIESEL	04/09 05/09	POST DPF POST DPF
	#OEM 03G 906 088 D				
	SKODA				
	OCTAVIA	1.9 TDI 2.0 TDI 2.0 TDI 16V 2.0 TDI RS	DIESEL DIESEL DIESEL DIESEL	04/10 05/10 04/13 06/13	POST DPF POST DPF POST DPF POST DPF
	SUPERCAB	1.9 TDI 2.0 TDI	DIESEL DIESEL	08/10 08/10	POST DPF POST DPF
	#OEM 03G 906 088 D				
	VOLKSWAGEN				
	EOS	2.0 TDI	DIESEL	06/08	POST DPF
	GOLF V	1.9 TDI 2.0 TDI	DIESEL DIESEL	04/08 04/08	POST DPF POST DPF
	GOLF PLUS	1.9 TDI 2.0 TDI	DIESEL DIESEL	05/09 05/11	POST DPF POST DPF
	JETTA III	2.0 TDI	DIESEL	05/10	POST DPF
	TIGUAN	2.0 TDI	DIESEL	07/	POST DPF
	#OEM 03G 906 088 D				

EGTS SENSOR

PT200



EXHAUST GAS TEMPERATURE SENSOR ABGASTEMPERATUR

PRODUCT	MODEL	ENGINE	FUEL	YEAR	POSITION				
9507	VOLKSWAGEN PASSAT								
						1.6 TDI	DIESEL	09/14	POST DPF
						2.0 TDI	DIESEL	08/10	POST DPF
2.0 TDI 16V						DIESEL	05/10	POST DPF	
	2.0 Blue TDI	DIESEL	09/10	POST DPF					
	PASSAT CC	2.0 TDI	DIESEL	08/12	POST DPF				

#OEM 03L 906 088 CE

PRODUCT	MODEL	ENGINE	FUEL	YEAR	POSITION				
9508	AUDI A4 A5 A6 A8 Q5 Q7								
						2.7 TDI, 3.0 TDI	DIESEL	06/09	PRE CAT/TBC
						3.0 TDI	DIESEL	08/	PRE TBC
						3.0 TDI	DIESEL	04/11	PRE TBC
						3.0 TDI	DIESEL	03/10	PRE TBC
						3.0 TDI	DIESEL	08/	PRE TBC
						3.0 TDI	DIESEL	06/15	PRE TBC
		VOLKSWAGEN PHAETON TOUAREG							
	3.0 V6 TDI						DIESEL	04/	PRE TBC
	3.0 TDI 3.0 V6 TDI						DIESEL DIESEL	06/10 10/	PRE TBC PRE TBC

#OEM 059.906.088.A

#OEM 059.906.088.A

EGTS SENSOR

PT200



EXHAUST GAS TEMPERATURE SENSOR ABGASTEMPERATUR

PRODUCT	MODEL	ENGINE	FUEL	YEAR	POSITION
9509 	VOLVO				
	S60 I	2.4 D, 2.4 D5	DIESEL	05/10	POST DPF
	V70 II	2.4 D 2.4 D5	DIESEL DIESEL	05/07 01/07	POST DPF POST DPF
	XC70	2.4 D5 AWD	DIESEL	05/07	POST DPF
#OEM 30729648					

PRODUCT	MODEL	ENGINE	FUEL	YEAR	POSITION
9510 	VOLKSWAGEN				
	AMAROK	2.0 TDI/BitDI	DIESEL	2010/	PRE DPF
#OEM 03L.906.088.FE					

PRODUCT	MODEL	ENGINE	FUEL	YEAR	POSITION
9511 	VOLKSWAGEN				
	AMAROK	2.0 TDI/BitDI	DIESEL	10/	POST DPF
	MULTIVAN	2.0 TDI	DIESEL	09/	PRE DPF
	TRANSPORTER	2.0 TDI	DIESEL	09/	PRE DPF
#OEM 03L 906 088 AF					

EGTS SENSOR

PT200







EXHAUST GAS TEMPERATURE SENSOR ABGASTEMPERATUR

PRODUCT	MODEL	ENGINE	FUEL	YEAR	POSITION
9512	VOLKSWAGEN				
	AMAROK	2.0 TDI/BitDI	DIESEL	10/	PRE TURBO





#OEM 03L.906.088.JK - 03L.906.088.FQ



PRODUCT	MODEL	ENGINE	FUEL	YEAR	POSITION
9513	MERCEDES-BENZ				
	C-CLASS	C350 C350 CGI	DIESEL DIESEL	11/ 11/14	PRE CAT PRE CAT
	E-CLASS	E300 E350	DIESEL DIESEL	11/ 11/	PRE CAT PRE CAT
	GLK-CLASS	350	DIESEL	08/15	PRE CAT

#OEM 000.905.79.01



PRODUCT	MODEL	ENGINE	FUEL	YEAR	POSITION
9514	AUDI				
	A3	1.9 TDI 2.0 TDI	DIESEL DIESEL	03/10 05/12	PRE DPF PRE DPF

#OEM 03G.906.088



CONTINUING...

EGTS SENSOR

PT200



EXHAUST GAS TEMPERATURE SENSOR ABGASTEMPERATUR





PRODUCT	MODEL	ENGINE	FUEL	YEAR	POSITION
 <p>9514</p>	SEAT				
	ALTEA	1.9 TDI 2.0 TDI	DIESEL DIESEL	04/ 06/	PRE DPF PRE DPF
	LEON	2.0 TDI	DIESEL	05/10	PRE DPF
	TOLEDO III	1.9 TDI 2.0 TDI	DIESEL DIESEL	04/09 05/09	PRE DPF PRE DPF
	#OEM 03G.906.088				
	SKODA				
	OCTAVIA	1.9 TDI 2.0 TDI	DIESEL DIESEL	04/10 05/10	PRE DPF PRE DPF
	SUPERB	1.9 TDI 2.0 TDI	DIESEL DIESEL	08/10 08/10	PRE DPF PRE DPF
	#OEM 03G.906.088				
	VOLKSWAGEN				
	CADDY III	1.9 TDI 2.0 TDI	DIESEL DIESEL	05/10 07/10	PRE DPF PRE DPF
	EOS	2.0 TDI	DIESEL	07/08	PRE DPF
	GOLF V	1.9 TDI 2.0 TDI	DIESEL DIESEL	04/08 04/09	PRE DPF PRE DPF
	GOLF PLUS	1.9 TDI	DIESEL	05/11	PRE DPF
	JETTA III	1.9 TDI	DIESEL	05/10	PRE DPF
	PASSAT	1.9 TDI 2.0 TDI	DIESEL DIESEL	05/10 05/10	PRE DPF PRE DPF
	TOURAN	1.9 TDI 2.0 TDI	DIESEL DIESEL	05/10 05/10	PRE DPF PRE DPF
	#OEM 03G.906.088.K				





EGTS SENSOR





PT200



EXHAUST GAS TEMPERATURE SENSOR ABGASTEMPERATUR

PRODUCT	MODEL	ENGINE	FUEL	YEAR	POSITION
	9515				
	AUDI				
	A6	2.0 TDI	DIESEL	08/11	PRE DPF
	#OEM 03L906088AB				
	SEAT				
EXEO	2.0 TDI	DIESEL	08/11	PRE DPF	
EXEO ST	2.0 TDI	DIESEL	08/11	PRE DPF	
	#OEM 03L906088AB				

PRODUCT	MODEL	ENGINE	FUEL	YEAR	POSITION
	9516				
	VOLKSWAGEN				
	CRAFTER 30-35	2.0 TDI	DIESEL	11/	POST DPF
	CRAFTER 30-50	2.0 TDI	DIESEL	11/	POST DPF
	#OEM 03L906088DN				





PRODUCT	MODEL	ENGINE	FUEL	YEAR	POSITION
	9517				
	MERCEDES-BENZ				
	M-CLASS	ML 300 CDI ML 320 CDI ML 350 CDI	DIESEL DIESEL DIESEL	09/11 05/09 09/	PRE DPF PRE DPF PRE DPF
	R-CLASS	R 280 CDI R 300 CDI R 320 CDI R 350 CDI	DIESEL DIESEL DIESEL DIESEL	06/ 09/ 06/ 06/	PRE DPF PRE DPF PRE DPF PRE DPF
	G-CLASS	G 350 CDI	DIESEL	11/	PRE DPF
	GL-CLASS	GL 320 CDI	DIESEL	06/	PRE DPF
	#OEM 008.153.35.28				

EGTS SENSOR





PT200



EXHAUST GAS TEMPERATURE SENSOR ABGASTEMPERATUR

PRODUCT	MODEL	ENGINE	FUEL	YEAR	POSITION
9518 	MERCEDES-BENZ SPRINTER 3T				
		209 CDI	DIESEL	06/09	PRE CAT
		210 CDI	DIESEL	09/13	PRE CAT
		211 CDI	DIESEL	06/09	PRE CAT
		213 CDI	DIESEL	06/09	PRE CAT
		215 CDI	DIESEL	06/09	PRE CAT
		216 CDI	DIESEL	09/19	PRE CAT
		218 CDI	DIESEL	06/09	PRE CAT
		219 CDI	DIESEL	09/	PRE CAT
		SPRINTER 3,5T	311 CDI	DIESEL	08/09
	313 CDI		DIESEL	06/	PRE CAT
	315 CDI		DIESEL	06/09	PRE CAT
	316 CDI		DIESEL	09/	PRE CAT
	318 CDI		DIESEL	08/09	PRE CAT
	319 CDI		DIESEL	09/	PRE CAT
	SPRINTER 4,6T	415 CDI	DIESEL	06/09	PRE CAT
	SPRINTER 5,0T	509 CDI	DIESEL	06/09	PRE CAT
		511 CDI	DIESEL	06/09	PRE CAT
		513 CDI	DIESEL	06/	PRE CAT
		515 CDI	DIESEL	06/09	PRE CAT
518 CDI		DIESEL	06/09	PRE CAT	

#OEM 007.153.62.28

PRODUCT	MODEL	ENGINE	FUEL	YEAR	POSITION
9519 	AUDI A4 A5 Q5				
		2.0 TDI	DIESEL	07/15	PRE DPF
		2.0 TDI	DIESEL	08/17	PRE DPF
		2.0 TDI	DIESEL	09/	PRE DPF
	SEAT EXEO ST	2.0 TDI	DIESEL	09/	POST DPF

#OEM 03L 906 088 D





#OEM 03L 906 088 D





EGTS SENSOR

PT200



EXHAUST GAS TEMPERATURE SENSOR ABGASTEMPERATUR

PRODUCT	MODEL	ENGINE	FUEL	YEAR	POSITION
 <p>9520</p>	<p>AUDI</p> <p>A3</p> <p>#OEM 04L.906.088.B</p>	 <p>1.6 TDI</p>	 <p>DIESEL</p>	 <p>12/</p>	 <p>POST DPF</p>
	<p>SEAT</p> <p>LEON</p> <p>#OEM 04L.906.088.B</p>	<p>1.6 TDI</p>	<p>DIESEL</p>	<p>12/</p>	<p>POST DPF</p>
	<p>SKODA</p> <p>OCTAVIA III</p> <p>#OEM 04L.906.088.B</p>	<p>1.6 TDI</p>	<p>DIESEL</p>	<p>12/</p>	<p>POST DPF</p>
	<p>VOLKSWAGEN</p> <p>GOLF VII</p> <p>#OEM 04L.906.088.B</p>	<p>1.6 TDI</p>	<p>DIESEL</p>	<p>12/</p>	<p>POST DPF</p>

PRODUCT	MODEL	ENGINE	FUEL	YEAR	POSITION
 <p>9521</p>	<p>AUDI</p> <p>A4</p> <p>#OEM 8E0.906.088</p>	 <p>2.0 TDI 1.9 TDI 2.0 TDI 16V</p>	 <p>DIESEL DIESEL DIESEL</p>	 <p>06/09 04/08 04/08</p>	 <p>PRE DPF PRE DPF PRE DPF</p>

EGTS SENSOR

PT200



EXHAUST GAS TEMPERATURE SENSOR ABGASTEMPERATUR

PRODUCT	MODEL	ENGINE	FUEL	YEAR	POSITION
 <p>9522</p>	VOLVO				
	C30	D5	DIESEL	06/12	PRE CAT
	C70 II	2.4 D	DIESEL	07/13	PRE CAT
	S40 II	2.4 D5	DIESEL	06/10	PRE DPF
	S60 II	D3 D4 D5	DIESEL DIESEL DIESEL	10/15 12/14 11/15	PRE DPF PRE DPF PRE DPF
	S80 II	2.4 D D5 D5 AWD	DIESEL DIESEL DIESEL	06/ 06/ 07/	PRE DPF PRE DPF PRE DPF
	V50	2.4 TDI 2.4 D5	DIESEL DIESEL	07/10 06/10	PRE DPF PRE DPF
	V70 III	2.4 D D5 D5 AWD	DIESEL DIESEL DIESEL	07/10 09/15 11/15	PRE DPF PRE DPF PRE DPF
	XC70 II	2.4 D/D4 AWD D5	DIESEL DIESEL	11/15 11/15	PRE DPF PRE DPF
	XC60	2.4 D D5 AWD	DIESEL DIESEL	08/ 09/11	PRE DPF PRE DPF

#OEM 31293031

PRODUCT	MODEL	ENGINE	FUEL	YEAR	POSITION
 <p>9523</p>	GM-CHEVROLET				
	SILVERADO	2500 HD 6.6 V8 3500 HD 6.6 V8	DIESEL DIESEL	07/10 07/10	POST DPF POST DPF
	#OEM 12598444				
	GMC				
	SIERRA	2500 HD 6.6 V8 3500 HD 6.6 V8	DIESEL DIESEL	07/10 07/10	POST DPF POST DPF

#OEM 12623113

EGTS SENSOR

PT200



EXHAUST GAS TEMPERATURE SENSOR ABGASTEMPERATUR

PRODUCT	MODEL	ENGINE	FUEL	YEAR	POSITION
 <p>9524</p>	GM-CHEVROLET				
	EXPRESS 2500	6.6 V8 TD	DIESEL	10/15	DPF
	EXPRESS 3500	6.6 V8 TD	DIESEL	10/15	DPF
	EXPRESS 4500	6.6 V8 TD	DIESEL	10/15	DPF
	#OEM 12637488				
	GMC				
	SAVANA 2500	6.6 V8 TD	DIESEL	10/15	DPF
	SAVANA 3500	6.6 V8 TD	DIESEL	10/15	DPF
	SAVANA 4500	6.6 V8 TD	DIESEL	10/15	DPF
	#OEM 12637488				

PRODUCT	MODEL	ENGINE	FUEL	YEAR	POSITION
 <p>9525</p>	MERCEDES-BENZ				
	S350 BlueTec	3.0 V6 D	DIESEL	11/13	POST DPF
#OEM 000.905.01.32					

EGTS SENSOR

PT200



EXHAUST GAS TEMPERATURE SENSOR ABGASTEMPERATUR

PRODUCT	MODEL	ENGINE	FUEL	YEAR	POSITION
9526 	MERCEDES-BENZ				
	A-CLASS	A 200 CDI	DIESEL	12/	PRE TURBO
	B-CLASS	B 180 CDI B 200 DI	DIESEL DIESEL	11/ 11/	PRE TURBO PRE TURBO
	C-CLASS	C 320 CDI C 350 CDI CLA 200 CDI CLA 220 CDI CLS 220 BlueTec CLS 350 BlueTec	DIESEL DIESEL DIESEL DIESEL DIESEL DIESEL	07/14 11/14 13/ 13/ 14/ 14/	PRE TURBO PRE TURBO PRE TURBO PRE TURBO PRE TURBO PRE TURBO
	E-CLASS	E 280 CDI E 350 CDI	DIESEL DIESEL	05/08 09/	PRE TURBO PRE TURBO
	S-CLASS	S 350 CDI	DIESEL	09/13	PRE TURBO
	M-CLASS	M 350	DIESEL	11/	PRE TURBO
	R-CLASS	R 280 CDI R 300 CDI	DIESEL DIESEL	06/ 09/	PRE TURBO PRE TURBO
	GL-CLASS	GL 350 CDI	DIESEL	10/	PRE TURBO

#OEM 007.153.66.28

PRODUCT	MODEL	ENGINE	FUEL	YEAR	POSITION
9527 	MERCEDES-BENZ				
	C-CLASS	C 300 CDI C 320 CDI C 350 CDI CLS 350 BlueTec	DIESEL DIESEL DIESEL DIESEL	11/14 07/14 09/14 12/	PRE DPF PRE CAT PRE DPF PRE DPF
	E-CLASS	E 300 CDI E 350 BlueTec E 350 CDI	DIESEL DIESEL DIESEL	11/ 09/ 09/	PRE DPF PRE DPF PRE DPF
	S-CLASS	S 350 CGI	DIESEL	11/13	PRE CAT
	M-CLASS	ML 420 CDI ML 450 CDI	DIESEL DIESEL	06/09 09/11	PRE DPF PRE DPF
	GL-CLASS	GL 420 CDI GL 450 CDI	DIESEL DIESEL	06/09 09/	PRE DPF PRE DPF
	GLK-CLASS	320 CDI 350 CDI	DIESEL DIESEL	08/15 09/15	PRE CAT PRE CAT





#OEM 007.153.67.28 - 001.905.06.00 - 005.153.20.28

EGTS SENSOR





PT200







EXHAUST GAS TEMPERATURE SENSOR ABGASTEMPERATUR

PRODUCT	MODEL	ENGINE	FUEL	YEAR	POSITION
9528 	MERCEDES-BENZ				
	C-CLASS	CLS 320 CDI CLS 350 CDI	DIESEL DIESEL	05/10 05/10	POST CAT POST CAT
	E-CLASS	E 280 CDI E 300 Blue Tec E 320 CDI	DIESEL DIESEL DIESEL	05/08 07/08 05/08	POST CAT POST CAT POST CAT
	S-CLASS	S 350 CDI S 3420 CDI	DIESEL DIESEL	09/13 06/13	PRE DPF POST DPF

#OEM 007.153.74.28

PRODUCT	MODEL	ENGINE	FUEL	YEAR	POSITION
9529 	MERCEDES-BENZ				
	M-CLASS	ML 280 CDI ML 300 CDI ML 320 CDI ML 350 CDI	DIESEL DIESEL DIESEL DIESEL	05/09 09/11 05/09 10/11	PRE DPF PRE DPF PRE DPF PRE DPF
	G-CLASS	G 320 CDI GL 320 CDI	DIESEL DIESEL	06/ 06/09	PRE CAT PRE DPF

#OEM 000.905.43.05

PRODUCT	MODEL	ENGINE	FUEL	YEAR	POSITION
9530 	MERCEDES-BENZ				
	A-CLASS	160 CDI 180 CDI 200 CDI	DIESEL DIESEL DIESEL	04/12 04/12 04/12	POST CAT POST CAT POST CAT
	B-CLASS	180 CDI 200 CDI	DIESEL DIESEL	05/11 05/11	POST CAT POST CAT

#OEM 007.153.91.28 - 005.153.92.28

EGTS SENSOR

PT200



EXHAUST GAS TEMPERATURE SENSOR ABGASTEMPERATUR

PRODUCT	MODEL	ENGINE	FUEL	YEAR	POSITION
9531 	MERCEDES-BENZ				
	A-CLASS	A 160 CDI	DIESEL	04/12	PRE TURBO
	C-CLASS	C 200 CDI	DIESEL	03/07	POST DPF
		C 220 CDI	DIESEL	03/07	POST DPF
		CLC 200 CDI	DIESEL	08/11	POST DPF
		CLC 220 CDI	DIESEL	08/11	POST DPF
	GL-CLASS	GL320 CDI	DIESEL	09/09	POST DPF
		GL350 CDI	DIESEL	09/09	POST DPF
	GLE-CLASS	250d	DIESEL	15/15	PRE CAT
		350d	DIESEL	15/15	PRE CAT
	M-CLASS	ML280 CDI	DIESEL	05/09	POST DPF
		ML300 CDI	DIESEL	09/09	POST DPF
		ML320 CDI	DIESEL	05/09	POST DPF
		ML350 CDI	DIESEL	09/09	POST DPF
		ML420 CDI	DIESEL	06/09	POST DPF
		ML450 CDI	DIESEL	09/11	POST DPF
	SPRINTER 3t	209CDI	DIESEL	06/09	PRE CAT/DPF
		210CDI	DIESEL	09/09	PRE DPF
		211CDI	DIESEL	06/06	PRE CAT/DPF
		213CDI	DIESEL	06/06	PRE DPF
215CDI		DIESEL	06/06	PRE DPF	
216CDI		DIESEL	09/09	PRE DPF	
218CDI		DIESEL	06/06	PRE CAT/DPF	
219CDI		DIESEL	09/09	PRE CAT	
SPRINTER 3,5t	309CDI	DIESEL	06/06	PRE CAT/DPF	
	311CDI	DIESEL	06/06	PRE DPF	
	313CDI	DIESEL	06/06	PRE DPF	
	315CDI	DIESEL	06/06	PRE DPF	
	319CDI	DIESEL	09/09	PRE CAT	
SPRINTER 4,6t	419CDI	DIESEL	09/09	PRE CAT	
SPRINTER 5t	509CDI	DIESEL	06/06	PRE DPF	
	511CDI	DIESEL	06/06	PRE CAT/DPF	
	515CDI	DIESEL	06/06	PRE CAT/DPF	
	518CDI	DIESEL	06/06	PRE CAT/DPF	
	519CDI	DIESEL	09/09	PRE CAT	
VIANO	CDI 2.0	DIESEL	03/03	POST DPF	
	CDI 2.2	DIESEL	03/03	POST DPF	
VITO	111 CDI	DIESEL	03/03	POST DPF	
	115 CDI	DIESEL	03/03	POST DPF	

#OEM 008.153.34.28

EGTS SENSOR

PT200



EXHAUST GAS TEMPERATURE SENSOR ABGASTEMPERATUR

PRODUCT	MODEL	ENGINE	FUEL	YEAR	POSITION
9532 	MERCEDES-BENZ				
	C-CLASS	C 300 CDI C 350 CDI	DIESEL DIESEL	11/14 09/14	PRE TURBO PRE TURBO
	E-CLASS	E 300 CDI E 350 CDI	DIESEL DIESEL	09/10 09/	PRE TURBO PRE TURBO
	M-CLASS	ML 300 CDI ML 350 CDI	DIESEL DIESEL	09/11 09/11	PRE TURBO PRE TURBO
	R-CLASS	R 280 CDI R 320 CDI R 350 CDI	DIESEL DIESEL DIESEL	06/ 06/ 06/	PRE TURBO PRE TURBO PRE TURBO
	G-CLASS	G 350 CDI	DIESEL	11/	PRE TURBO
	GL-CLASS	GL 320 CDI	DIESEL	09/	PRE TURBO
	GLK-CLASS	GLK 350 CDI	DIESEL	09/10	PRE TURBO

#OEM 000.905.67.04 - 008.153.36.28

PRODUCT	MODEL	ENGINE	FUEL	YEAR	POSITION
9533 	MERCEDES-BENZ				
	C-CLASS	C 320 CDI C 350 CDI CLK 320 CDI	DIESEL DIESEL DIESEL	07/14 07/14 05/10	POST CAT POST CAT POST CAT
	E-CLASS	E 280 CDI E 300 CDI E 320 CDI	DIESEL DIESEL DIESEL	05/10 05/10 05/10	POST CAT POST CAT POST CAT
	S-CLASS	S 250 CDI	DIESEL	11/13	POST DPF

#OEM 008.153.40.28 - 000.905.89.00

EGTS SENSOR

PT200



EXHAUST GAS TEMPERATURE SENSOR ABGASTEMPERATUR

PRODUCT	MODEL	ENGINE	FUEL	YEAR	POSITION
9534 	SEAT				
	IBIZA V	1.2 TDI	DIESEL	10/	PRE CAT
	#OEM 03P.906.088.A				
	SKODA				
	FABIA II	1.2 TDI	DIESEL	10/14	PRE TURBO
	ROOMSTER	1.2 TDI	DIESEL	10/15	PRE TURBO
#OEM 03P.906.088.A					
VOLKSWAGEN					
POLO	1.2 TDI	DIESEL	09/	PRE TURBO	
#OEM 03P.906.088.A					





PRODUCT	MODEL	ENGINE	FUEL	YEAR	POSITION
9535 	AUDI				
	Q7	3.0 TDI 6.0 TDI	DIESEL DIESEL	06/10 08/14	PRE DPF PRE DPF
	#OEM 059.906.088.C				
	VOLKSWAGEN				
TOUAREG	3.0 TDI 3.0 V6 TDI	DIESEL DIESEL	06/10 04/10	PRE DPF PRE DPF	
#OEM 059.906.088.C					

EGTS SENSOR

PT200







EXHAUST GAS TEMPERATURE SENSOR ABGASTEMPERATUR

PRODUCT	MODEL	ENGINE	FUEL	YEAR	POSITION
9536	MERCEDES-BENZ	 C 220 BlueTec C 250 BlueTec C 300 BlueTec	 DIESEL DIESEL DIESEL	 14/16 13/ 14/	 PRE CAT PRE CAT PRE CAT
	C-CLASS				





#OEM 000.905.89.04



PRODUCT	MODEL	ENGINE	FUEL	YEAR	POSITION
9537	MERCEDES-BENZ	 CLS CLASS E-CLASS	 DIESEL DIESEL DIESEL	 11/ 05/09 11/	 PRE CAT PRE CAT PRE CAT
	CLS CLASS				
	E-CLASS				

#OEM 008.153.41.28



PRODUCT	MODEL	ENGINE	FUEL	YEAR	POSITION
9538	AUDI	 3.0 TDI	 DIESEL	 11/15 11/17 10/ 10/ 11/ 12/ 12/	 PRE DPF PRE DPF PRE DPF PRE DPF PRE DPF PRE DPF PRE DPF
	A4				
	A5				
	A6				
	A7				
	A8				
	Q5				
	Q7				

#OEM 059.906.088.BB



CONTINUING...

EGTS SENSOR

PT200











EXHAUST GAS TEMPERATURE SENSOR ABGASTEMPERATUR

PRODUCT	MODEL	ENGINE	FUEL	YEAR	POSITION
9538	VOLKSWAGEN	 3.0 V6 TDI	 DIESEL	 10/	 PRE DPF
	TOUAREG				

#OEM 059.906.088.BB



PRODUCT	MODEL	ENGINE	FUEL	YEAR	POSITION				
9539	AUDI	 3.0 TDI	 DIESEL	 11/15	 PRE TURBO				
	A4								
	A5								
	A6								
	A7								
	A8								
	Q5								
	Q7								
	VOLKSWAGEN					 3.0 V6 TDI	 DIESEL	 10/	 PRE TURBO
	TOUAREG								

#OEM 059.906.088.BJ

#OEM 059.906.088.CL







EGTS SENSOR

PT200







EXHAUST GAS TEMPERATURE SENSOR ABGASTEMPERATUR

PRODUCT	MODEL	ENGINE	FUEL	YEAR	POSITION
9540	AUDI	 3.0 TDI	 DIESEL	 09/12	 PRE CAT



AUDI
Q7
#OEM 059.906.088.T

PRODUCT	MODEL	ENGINE	FUEL	YEAR	POSITION
9541	VOLKSWAGEN	 2.0 TDI	 DIESEL	 09/	 POST DPF
	MULTIVAN T5	2.0 TDI	DIESEL	09/	POST DPF
	MULTIVAN T6	2.0 TDI	DIESEL	15/	POST DPF
	TRANSPORTER T5	2.0 TDI	DIESEL	09/	POST DPF
	TRANSPORTER T6	2.0 TDI	DIESEL	15/	POST DPF



VOLKSWAGEN
MULTIVAN T5
MULTIVAN T6
TRANSPORTER T5
TRANSPORTER T6
#OEM 03K.906.088.B

EGTS SENSOR

PT200



EXHAUST GAS TEMPERATURE SENSOR ABGASTEMPERATUR

PRODUCT	MODEL	ENGINE	FUEL	YEAR	POSITION
 <p>9542</p>	AUDI				
	A1	1.6 TDI	DIESEL	11/	POST DPF
	#OEM 03L.906.088.C				
	SEAT				
	IBIZA IV	1.2 TDI	DIESEL	10/	POST DPF
	IBIZA IV ST	1.2 TDI	DIESEL	10/	POST DPF
	IBIZA V	1.6 TDI	DIESEL	09/	POST DPF
	TOLEDO IV	1.6 TDI	DIESEL	12/	POST DPF
	#OEM 03P.906.088.D				
	SKODA				
	FABIA	1.2 TDI	DIESEL	10/14	POST DPF
		1.6 TDI	DIESEL	10/14	POST DPF
	RAPID	1.6 TDI	DIESEL	12/	POST DPF
	ROOMSTER	1.2 TDI	DIESEL	10/15	POST DPF
		1.6 TDI	1DIESEL	0/15	POST DPF
#OEM 03L.906.088.CH					
VOLKSWAGEN					
POLO	1.2 TDI, 1.6 TDI	DIESEL	09/	POST DPF	
#OEM 03P.906.088.D					

EGTS SENSOR

PT200



EXHAUST GAS TEMPERATURE SENSOR ABGASTEMPERATUR

PRODUCT	MODEL	ENGINE	FUEL	YEAR	POSITION
9543 	VOLKSWAGEN				
	BEETLE	2.0 TDI	DIESEL	11/	PRE TURBO
	GOLF VI	1.6 TDI 2.0 TDI 16V	DIESEL DIESEL	09/13 09/13	PRE TURBO PRE TURBO
	JETTA IV	2.0 TDI	DIESEL	11/	PRE TURBO
#OEM 03L.906.088.EJ					

PRODUCT	MODEL	ENGINE	FUEL	YEAR	POSITION
9544 	VOLKSWAGEN				
	BEETLE	2.0 TDI	DIESEL	11/	PRE CAT
	GOLF VI	1.6 TDI 2.0 TDI 16V	DIESEL DIESEL	09/13 09/13	PRE CAT PRE CAT
	JETTA III	2.0 TDI 16V	DIESEL	05/10	PRE CAT
	JETTA IV	2.0 TDI	DIESEL	11/	PRE CAT
#OEM 03L.906.088.T					





PRODUCT	MODEL	ENGINE	FUEL	YEAR	POSITION
9545 	PORSCHE				
	CAYENNE	3.0 D	DIESEL	10/	PRE DPF
	#OEM 059.906.088.BP				
	VOLKSWAGEN				
TOUAREG	3.0 V6 TDI	DIESEL	10/	PRE DPF	
#OEM 059.906.088.BP					

EGTS SENSOR

PT200



EXHAUST GAS TEMPERATURE SENSOR ABGASTEMPERATUR

PRODUCT	MODEL	ENGINE	FUEL	YEAR	POSITION
9546	VOLKSWAGEN				
	MULTIVAN T5	2.5 TDI	DIESEL	03/09	PRE DPF
	TRANSPORTER T5	2.5 TDI	DIESEL	03/09	PRE DPF

#OEM 070.906.088.AD



PRODUCT	MODEL	ENGINE	FUEL	YEAR	POSITION
9547	VOLKSWAGEN				
	TOUAREG	5.0 V10 TDI	DIESEL	02/10	PRE TURBO

#OEM 07Z.906.088.C



PRODUCT	MODEL	ENGINE	FUEL	YEAR	POSITION
9548	VOLKSWAGEN				
	TOUAREG	5.0 V10 TDI	DIESEL	06/08	POST DPF

#OEM 07Z.906.088.P







EGTS SENSOR

PT200



EXHAUST GAS TEMPERATURE SENSOR ABGASTEMPERATUR

PRODUCT	MODEL	ENGINE	FUEL	YEAR	POSITION
	9549				
	GM-CHEVROLET				
	EXPRESS 2500	-	DIESEL	08/15	POST DPF
	EXPRESS 3500	-	DIESEL	08/15	POST DPF
	EXPRESS 4500	-	DIESEL	08/15	POST DPF
	#OEM 12633560				
	GMC				
	SAVANA 2500	-	DIESEL	08/15	POST DPF
	SAVANA 3500	-	DIESEL	08/15	POST DPF
	SAVANA 4500	-	DIESEL	08/15	POST DPF
#OEM 12633560					





PRODUCT	MODEL	ENGINE	FUEL	YEAR	POSITION
	9550				
	FORD				
	F250	6.4 V8	DIESEL	08/10	POST DPF - PRE/POST CAT
	F350	6.4 V8	DIESEL	08/10	POST DPF - PRE/POST CAT
	F450	6.4 V8	DIESEL	08/10	POST DPF - PRE/POST CAT
	F550	6.4 V8	DIESEL	08/10	POST DPF - PRE/POST CAT
#OEM 8C3Z.5J213.D					





EGTS SENSOR

PT200



EXHAUST GAS TEMPERATURE SENSOR ABGASTEMPERATUR

PRODUCT	MODEL	ENGINE	FUEL	YEAR	POSITION
9551 	ALFA ROMEO MITO #OEM 51825680	 1.3 D Multijet	 DIESEL	 08/	 POST DPF
	FIAT PUNTO #OEM 55218471 - 51799538	1.3 D Multijet	DIESEL	12/	POST DPF

PRODUCT	MODEL	ENGINE	FUEL	YEAR	POSITION
9552 	MERCEDES-BENZ CLC-CLASS CLC 200 CDI CLC 220 CDI CLK 220 CDI	 CLC 200 CDI CLC 220 CDI CLK 220 CDI	 DIESEL DIESEL DIESEL	 08/11 08/11 05/09	 POST DPF POST DPF POST DPF
	E-CLASS E 200 CDI E 220 CDI E 280 CDI E 300 BlueTec E 320 CDI	E 200 CDI E 220 CDI E 280 CDI E 300 BlueTec E 320 CDI	DIESEL DIESEL DIESEL DIESEL DIESEL	02/08 02/08 05/09 07/08 05/08	POST CAT POST CAT POST CAT POST CAT POST CAT
	S-CLASS S 320 CDI	S 320 CDI	DIESEL	05/13	POST DPF
	R-CLASS R 280 CDI R 300 CDI R 320 CDI R 350 CDI	R 280 CDI R 300 CDI R 320 CDI R 350 CDI	DIESEL DIESEL DIESEL DIESEL	06/ 09/ 06/ 09/	POST CAT POST CAT POST CAT POST CAT
	#OEM 007.153.63.28 - 005.153.11.28				

EGTS SENSOR

PT200



EXHAUST GAS TEMPERATURE SENSOR ABGASTEMPERATUR

PRODUCT	MODEL	ENGINE	FUEL	YEAR	POSITION
9553 	MERCEDES-BENZ				
	C-CLASS	C 180 CDI C 200 CDI C 220 CDI C 250 CDI CLS 220 BlueTec CLS 250 BlueTec	DIESEL DIESEL DIESEL DIESEL DIESEL DIESEL	11/14 11/14 08/14 08/14 14/ 14/	PRE TURBO PRE TURBO PRE TURBO PRE TURBO PRE TURBO PRE TURBO
	E-CLASS	E 220 CDI E 220 CDI E 250 CDI	DIESEL DIESEL DIESEL	09/ 09/ 09/	PRE TURBO PRE TURBO PRE TURBO
	S-CLASS	S 250 CDI SLK 250 CDI	DIESEL DIESEL	11/13 12/	PRE TURBO PRE TURBO
	M-CLASS	ML 250 CDI	DIESEL	11/	PRE TURBO
	G-CLASS	GLE 250 D GLK 200 CDI GLK 220 CDI GLK 250 CDI	DIESEL DIESEL DIESEL DIESEL	15/ 10/15 08/15 09/15	PRE TURBO PRE TURBO PRE TURBO PRE TURBO
	VITO	110 CDI 113 CDI 116 CDI	DIESEL DIESEL DIESEL	10/ 10/ 10/	PRE TURBO PRE TURBO PRE TURBO
	SPRINTER 3T	210 CDI 213 CDI 216 CDI	DIESEL DIESEL DIESEL	09/13 06/16 06/	PRE TURBO PRE TURBO PRE TURBO
	SPRINTER 3,5 T	310 CDI 311 CDI 313 CDI 315 CDI 316 CDI	DIESEL DIESEL DIESEL DIESEL DIESEL	06/ 06/ 06/ 06/ 09/	PRE TURBO PRE TURBO PRE TURBO PRE TURBO PRE TURBO
	SPRINTER 5 T	510 CDI 513 CDI 516 CDI	DIESEL DIESEL DIESEL	09/16 06/ 06/	PRE TURBO PRE TURBO PRE TURBO

#OEM 008.153.22.28 - 000.905.64.04

EGTS SENSOR

PT200



EXHAUST GAS TEMPERATURE SENSOR ABGASTEMPERATUR

PRODUCT	MODEL	ENGINE	FUEL	YEAR	POSITION
9554	MERCEDES-BENZ				
	C-CLASS				
	E-CLASS	E 200 CDI E 220 CDI	DIESEL DIESEL	06/08 06/09	POST TURBO POST TURBO

#OEM 007.153.99.28

PRODUCT	MODEL	ENGINE	FUEL	YEAR	POSITION
9555	OPEL				
	ASTRA H				
	ZAFIRA B	1.7 CDTI	DIESEL	08/	POST CAT

#OEM 55566631 - 5855377

PRODUCT	MODEL	ENGINE	FUEL	YEAR	POSITION
9556	MERCEDES-BENZ				
	C-CLASS				
	E-CLASS	E 200 CDI E 220 CDI E 250 CDI E 300	DIESEL DIESEL DIESEL DIESEL	09/ 09/ 09/ 11/	PRE DPF PRE DPF PRE DPF PRE DPF

#OEM 001.905.07.00 - 007.153.94.28

EGTS SENSOR

PT200



EXHAUST GAS TEMPERATURE SENSOR ABGASTEMPERATUR

PRODUCT	MODEL	ENGINE	FUEL	YEAR	POSITION
	9557				
	VOLKSWAGEN				
	BEETLE	2.0 TDI	DIESEL	11/	PRE DPF
	GOLF VI	2.0 TDI	DIESEL	09/13	PRE DPF
	JETTA III	2.0 16V TDI	DIESEL	05/10	PRE DPF
JETTA IV	2.0 TDI	DIESEL	11/	PRE DPF	
#OEM 03L.906.088.J					

PRODUCT	MODEL	ENGINE	FUEL	YEAR	POSITION
	9558				
	AUDI				
	A4	2.7 TDI 3.0 TDI	DIESEL DIESEL	07/12 08/10	POST DPF POST DPF
	A5	2.7 TDI 3.0 TDI	DIESEL DIESEL	07/12 08/10	POST DPF POST DPF
	Q5	3.0 TDI	DIESEL	08/	POST DPF
#OEM 059906088AT - 059906088AK					





PRODUCT	MODEL	ENGINE	FUEL	YEAR	POSITION
	9559				
	AUDI				
	A4	3.0 TDI	DIESEL	11/15	PRE DPF
	A5	3.0 TDI	DIESEL	11/17	PRE DPF
	A6	3.0 TDI	DIESEL	12/	PRE DPF
A8	3.0 TDI	DIESEL	10/	PRE DPF	
#OEM 8K0906088					

EGTS SENSOR

PT200







EXHAUST GAS TEMPERATURE SENSOR ABGASTEMPERATUR

PRODUCT	MODEL	ENGINE	FUEL	YEAR	POSITION
9561	VOLKSWAGEN				
	CRAFTER 30-35	2.5 TDI	DIESEL	06/13	POST DPF
	CRAFTER 30-50	2.5 TDI	DIESEL	06/13	POST DPF

#OEM 070.906.088.A



PRODUCT	MODEL	ENGINE	FUEL	YEAR	POSITION
9562	SEAT				
	EXEO	2.0 TDI	DIESEL	08/	POST DPF
	EXEO ST	2.0 TDI	DIESEL	09/	POST DPF

#OEM 03G906088F



VOLKSWAGEN

CADDY III	1.9 TDI 2.0 TDI	DIESEL DIESEL	04/08 07/10	POST DPF POST DPF
TOURAN	1.9 TDI 2.0 TDI	DIESEL DIESEL	04/08 05/10	POST DPF POST DPF

#OEM 03G906088F

EGTS SENSOR

PT200



EXHAUST GAS TEMPERATURE SENSOR ABGASTEMPERATUR

PRODUCT	MODEL	ENGINE	FUEL	YEAR	POSITION
9563 	MERCEDES-BENZ				
	A CLASS	A 180 CDI A 200 CDI A 220 CDI	DIESEL DIESEL DIESEL	12/ 12/ 12/	PRE TURBO PRE TURBO PRE TURBO
	B-CLASS	B 160 CDI B 180 CDI B 200 CDI B 220 CDI	DIESEL DIESEL DIESEL DIESEL	13/ 13/ 14/ 14/	PRE TURBO PRE TURBO PRE TURBO PRE TURBO
	C-CLASS	C 180 CDI C 200 CDI C 220 CDI C 250 CDI	DIESEL DIESEL DIESEL DIESEL	11/14 11/14 08/14 11/14	PRE DPF PRE DPF PRE DPF PRE DPF
	E-CLASS	E 350 CGI E 200 CDI E 220 CDI E 250 CDI E 300 CDI	DIESEL DIESEL DIESEL DIESEL DIESEL	07/09 09/ 09/ 09/ 09/	POST DPF POST DPF POST DPF POST DPF POST DPF
	M-CLASS	ML 280 CDI ML 300 CDI ML 320 CDI ML 350 CDI	DIESEL DIESEL DIESEL DIESEL	05/09 09/11 05/09 09/11	PRE DPF PRE DPF PRE DPF PRE DPF
	G-CLASS	G 320 CDI	DIESEL	06/	PRE CAT
	GL-CLASS	GL 320 CDI GL 350 CDI	DIESEL DIESEL	09/ 09/	PRE DPF PRE DPF

#OEM 81532728 - 71539028

PRODUCT	MODEL	ENGINE	FUEL	YEAR	POSITION
9564 	OPEL				
	ASTRA J	1.7 CDTI	DIESEL	09/	POST CAT

#OEM 855574 - 55566575



EGTS SENSOR

PT200



EXHAUST GAS TEMPERATURE SENSOR ABGASTEMPERATUR

PRODUCT	MODEL	ENGINE	FUEL	YEAR	POSITION
 <p>9565</p>	ALFA ROMEO				
	GIULIETTA	1.6 JTDM 2.0 JTDM	DIESEL DIESEL	10/ 13/	PRE DPF PRE DPF
	#OEM 51825681				
	FIAT				
	BRAVO II	1.6 D Multijet	DIESEL	07/14	PRE DPF
	#OEM 51825681				
	LANCIA				
	DELTA III	1.6 D Multijet 2.0 D Multijet	DIESEL DIESEL	08/14 08/14	PRE DPF PRE DPF
	#OEM 51825681				
	OPEL				
	ASTRA J	2.0 CDTI	DIESEL	09/	PRE CAT
	ASTRA J GTC	2.0 CDTI	DIESEL	11/	PRE DPF
	INSIGNIA	2.0 CDTI	DIESEL	08/	PRE CAT
	ZAFIRA C	2.0 CDTI	DIESEL	11/	PRE CAT
	#OEM 55566185 55489472 855387				
	VAUXHALL				
ASTRA Mk VI	2.0 CDTI	DIESEL	09/	PRE DPF	
INSIGNIA Mk I	2.0 CDTI	DIESEL	08/17	PRE CAT	
ZAFIRA Mk III	2.0 CDTI	DIESEL	11/	PRE CAT	
#OEM 55566185					

EGTS SENSOR

PT200



EXHAUST GAS TEMPERATURE SENSOR ABGASTEMPERATUR

PRODUCT	MODEL	ENGINE	FUEL	YEAR	POSITION
9566 	AUDI				
	A4	2.7 TDI 3.0 TDI	DIESEL DIESEL	07/12 08/10	PRE DPF PRE DPF
	A5	2.7 TDI 3.0 TDI	DIESEL DIESEL	07/12 09/12	PRE DPF PRE DPF
	A6	3.0 TDI Quattro	DIESEL	10/18	PRE DPF
	A7	3.0 TDI Quattro	DIESEL	10/16	PRE DPF
	A8	3.0 TDI Quattro	DIESEL	10/18	PRE DPF

#OEM 059.906.088.M - 059.906.088.BK

PRODUCT	MODEL	ENGINE	FUEL	YEAR	POSITION
9567 	VOLKSWAGEN				
	CADDY III	1.6 TDI	DIESEL	10/15	PRE DPF
	CADDY IV	1.6 TDI	DIESEL	15/	POST CAT
	TOURAN	1.6 TDI	DIESEL	10/15	PRE DPF

#OEM 03L906088DH

PRODUCT	MODEL	ENGINE	FUEL	YEAR	POSITION
9568 	AUDI				
	Q7	4.2 TDI 6.0 TDI	DIESEL DIESEL	07/15 08/14	PRE DPF PRE CAT
	VOLKSWAGEN				
	TOUAREG	5.0 TDI	DIESEL	02/10	PRE DPF

#OEM 07Z.906.088.A

EGTS SENSOR

PT200



EXHAUST GAS TEMPERATURE SENSOR ABGASTEMPERATUR

PRODUCT	MODEL	ENGINE	FUEL	YEAR	POSITION
 <p>9569</p>	VOLKSWAGEN				
	BEETLE	2.0 TDI	DIESEL	11/	POST DPF
	GOLF VI	2.0 TDI	DIESEL	09/13	POST DPF
	JETTA III	2.0 TDI 16V	DIESEL	05/10	POST DPF
	JETTA IV	2.0 TDI	DIESEL	11/	POST DPF
#OEM 03L906088G					

PRODUCT	MODEL	ENGINE	FUEL	YEAR	POSITION
 <p>9570</p>	VOLKSWAGEN				
	CRAFTER 30-35	2.5 TDI	DIESEL	06/13	PRE DPF
	CRAFTER 30-50	2.5 TDI	DIESEL	06/13	PRE DPF
#OEM 070.906.088.AA					

PRODUCT	MODEL	ENGINE	FUEL	YEAR	POSITION
 <p>9571</p>	FIAT				
	BRAVO II	1.6 D Multijet	DIESEL	08/	PRE DPF
		1.9 D Multijet	DIESEL	06/	PRE DPF
2.0 D Multijet		DIESEL	08/	PRE DPF	
STILO	1.9 D Multijet	DIESEL	01/08	PRE DPF	
#OEM 55190624					

EGTS SENSOR

PT200



EXHAUST GAS TEMPERATURE SENSOR ABGASTEMPERATUR

PRODUCT	MODEL	ENGINE	FUEL	YEAR	POSITION
9572 	VOLKSWAGEN				
	CRAFTER 30-35	2.0 TDI	DIESEL	11/16	PRE DPF
	CRAFTER 30-50	2.0 TDI	DIESEL	11/16	PRE DPF
	#OEM 03L906088DM				





PRODUCT	MODEL	ENGINE	FUEL	YEAR	POSITION
9573 	SEAT				
	CORDOBA	1.4 TDI	DIESEL	05/09	POST DPF
		1.9 TDI	DIESEL	02/09	POST DPF
	IBIZA IV	1.4 TDI	DIESEL	05/09	POST DPF
		1.9 TDI	DIESEL	02/09	POST DPF
	IBIZA V	1.4 TDI	DIESEL	08/10	POST DPF
		1.9 TDI	DIESEL	08/10	POST DPF
	#OEM 045.906.088.D				
	SKODA				
	FABIA II	1.9 TDI	DIESEL	07/10	POST DPF
ROOMSTER	1.4 TDI	DIESEL	06/10	POST DPF	
	1.9 TDI	DIESEL	06/10	PRE TURBO	
#OEM 045.906.088.D					
VOLKSWAGEN					
POLO	1.9 TDI	DIESEL	01/09	POST DPF	
#OEM 045.906.088.D					





EGTS SENSOR





PT200



EXHAUST GAS TEMPERATURE SENSOR ABGASTEMPERATUR

PRODUCT	MODEL	ENGINE	FUEL	YEAR	POSITION
9574	AUDI				
	A6	3.0 TDI	DIESEL	11/	PRE CAT
	A7	3.0 TDI	DIESEL	10/	-
#OEM 8K0.906.088.C					

PRODUCT	MODEL	ENGINE	FUEL	YEAR	POSITION
9575	AUDI				
	A4	2.0 TDI 1.9 TDI 2.0 16V TDI	DIESEL DIESEL DIESEL	06/09 04/08 04/08	POST DPF POST DPF POST DPF
	A6	2.0 TDI	DIESEL	05/11	POST DPF
#OEM 03G.906.088.BA					

PRODUCT	MODEL	ENGINE	FUEL	YEAR	POSITION
9576	FIAT				
	BRAVO II	1.4 1.4 T-Jet 1.9 D Multijet	DIESEL DIESEL DIESEL	07/ 07/ 07/	POST CAT POST CAT POST DPF
	STILO	1.9 JTD 1.9 D Multijet	DIESEL DIESEL	04/08 05/08	POST DPF POST DPF
#OEM 51791310 - 55208250					

EGTS SENSOR

PT200



EXHAUST GAS TEMPERATURE SENSOR ABGASTEMPERATUR

PRODUCT	MODEL	ENGINE	FUEL	YEAR	POSITION
9577 	GM-CHEVROLET				
	SIGNUM	3.0 V6 CDTI	DIESEL	05/	POST DPF
	VECTRA C	3.0 CDTI	DIESEL	05/	POST DPF
	#OEM 55557600				
	VAUXHALL				
	SIGNUM	3.0 V6 CDTI	DIESEL	05/	POST DPF
VECTRA C	3.0 CDTI	DIESEL	05/	POST DPF	
#OEM 855425					





PRODUCT	MODEL	ENGINE	FUEL	YEAR	POSITION
9578 	GM-CHEVROLET				
	SILVERADO 2500 HD	6.6 V8	DIESEL	11/16	POST DPF
	SILVERADO 3500 HD	6.6 V8	DIESEL	11/16	POST DPF
	#OEM 12622555				
	GMC				
	SIERRA 2500 HD	6.6 V8	DIESEL	11/16	POST DPF
SIERRA 3500 HD	6.6 V8	DIESEL	11/16	POST DPF	
#OEM 12622555					





EGTS SENSOR

PT200



EXHAUST GAS TEMPERATURE SENSOR ABGASTEMPERATUR

PRODUCT	MODEL	ENGINE	FUEL	YEAR	POSITION
9579 	VOLKSWAGEN TOUAREG #OEM 07Z.906.088.N	 5.0 V10 TDI	 DIESEL	 06/08	 POST DPF





PRODUCT	MODEL	ENGINE	FUEL	YEAR	POSITION
9580 	AUDI A3 #OEM 03L.906.088.L	 2.0 16V TDI	 DIESEL	 10/10	 PRE TURBO
	VOLKSWAGEN JETTA	2.0 16V TDI	DIESEL	09/14	PRE TURBO
	BEETLE	2.0 16V TDI	DIESEL	13/13	PRE TURBO
	GOLF	2.0 16V TDI	DIESEL	10/11	PRE TURBO
	#OEM 03L.906.088.L				





EGTS SENSOR









PT200



EXHAUST GAS TEMPERATURE SENSOR ABGASTEMPERATUR

PRODUCT	MODEL	ENGINE	FUEL	YEAR	POSITION
9581 	VOLKSWAGEN				
	PASSAT	2.0 TDI	DIESEL	10/14	PRE TURBO
	CC	2.0 TDI	DIESEL	11/	PRE TURBO
#OEM 03L.906.088.ED					

PRODUCT	MODEL	ENGINE	FUEL	YEAR	POSITION
9582 	VOLKSWAGEN				
	PASSAT	2.0 TDI	DIESEL	12/14	PRE DPF
	#OEM 03L906088EE				

PRODUCT	MODEL	ENGINE	FUEL	YEAR	POSITION	
9583 	AUDI					
	Q7	3.0 V6 TDI	DIESEL	07/15	PRE DPF	
	#OEM 059.906.088.AB					
	VOLKSWAGEN					
TOUAREG	3.0 V6 TDI	DIESEL	04/10	PRE DPF		
#OEM 059.906.088.AB						

EGTS SENSOR

PT200



EXHAUST GAS TEMPERATURE SENSOR ABGASTEMPERATUR

PRODUCT	MODEL	ENGINE	FUEL	YEAR	POSITION
9584 	FORD				
	F250	6.7 V8	DIESEL	11/16	POST DPF/CAT/SCR
	F350	6.7 V8	DIESEL	11/16	POST DPF/CAT/SCR
	F450	6.7 V8	DIESEL	11/16	POST DPF/CAT/SCR
	F550	6.7 V8	DIESEL	11/16	POST DPF/CAT/SCR

#OEM AC3Z.5J213.B

PRODUCT	MODEL	ENGINE	FUEL	YEAR	POSITION
9585 	OPEL				
	ASTRA J	1.3 CDTI	DIESEL	09/	PRE CAT
	CORSA D	1.3 CDTI	DIESEL	06/	PRE CAT
	MERIVA B	1.3 CDTI	DIESEL	10/	PRE CAT
	VAUXHALL				
	ASTRA Mk VI	1.3 CDTI	DIESEL	09/	PRE CAT
	CORSA Mk III	1.3 CDTI	DIESEL	06/14	PRE CAT
MERIVA Mk II	1.3 CDTI	DIESEL	10/	PRE CAT	

#OEM 55564977

EGTS SENSOR

PT200



EXHAUST GAS TEMPERATURE SENSOR ABGASTEMPERATUR

PRODUCT	MODEL	ENGINE	FUEL	YEAR	POSITION
 <p>9586</p>	SEAT				
	CORDOBA	1.4 TDI 1.9 TDI	DIESEL DIESEL	05/09 02/09	PRE DPF PRE DPF
	IBIZA IV	1.4 TDI 1.9 TDI	DIESEL DIESEL	05/09 02/09	PRE DPF PRE DPF
	IBIZA V	1.4 TDI 1.9 TDI	DIESEL DIESEL	08/10 08/10	PRE DPF PRE DPF
	#OEM 03G.906.088.AC				
	SKODA				
	FABIA II	1.4 TDI 1.9 TDI	DIESEL DIESEL	07/10 07/10	PRE DPF PRE DPF
	ROOMSTER	1.4 TDI 1.9 TDI	DIESEL DIESEL	06/10 06/10	PRE DPF PRE DPF
	#OEM 03G.906.088.AC				
	VOLKSWAGEN				
POLO	1.4 TDI 1.9 TDI	DIESEL DIESEL	05/09 01/09	PRE DPF PRE DPF	
#OEM 03G.906.088.AC					

PRODUCT	MODEL	ENGINE	FUEL	YEAR	POSITION
 <p>9587</p>	AUDI				
	A2	1.6 FSI	DIESEL	02/05	POST DPF
	A3	1.6 FSI	DIESEL	03/07	POST DPF
#OEM 036.906.088.C					





CONTINUING...

EGTS SENSOR





PT200



EXHAUST GAS TEMPERATURE SENSOR ABGASTEMPERATUR

PRODUCT	MODEL	ENGINE	FUEL	YEAR	POSITION
9587 	VOLKSWAGEN				
	BORA	1.6 FSI	DIESEL	02/05	POST CAT
	GOLF IV	1.6 FSI	DIESEL	02/06	POST CAT
	GOLF V	1.6 FSI	DIESEL	03/08	POST CAT
	LUPO	1.4 FSI	DIESEL	01/05	POST CAT
	POLO	1.4 FSI	DIESEL	02/06	POST CAT

#OEM 036.906.088.C

PRODUCT	MODEL	ENGINE	FUEL	YEAR	POSITION
9588 	AUDI				
	A1	1.6 TDI	DIESEL	10/	POST DPF
	#OEM 03G.906.088.AF				
	SEAT				
	IBIZA V	1.2 TDI 1.6 TDI	DIESEL DIESEL	10/ 09/	POST DPF POST DPF
	TOLEDO	1.6 TDI	DIESEL	12/	POST DPF
	#OEM 03G.906.088.AF				
	SKODA				
	FABIA II	1.2 TDI 1.6 TDI	DIESEL DIESEL	10/14 10/14	POST DPF POST DPF
	RAPID	1.6 TDI	DIESEL	12/	POST DPF
	ROOMSTER	1.2 TDI 1.6 TDI	DIESEL DIESEL	10/15 10/15	POST DPF POST DPF
	#OEM 03G.906.088.AF				
	VOLKSWAGEN				
POLO	1.2 TDI 1.6 TDI	DIESEL DIESEL	09/ 09/	POST DPF POST DPF	





#OEM 03G.906.088.AF





EGTS SENSOR

PT200



EXHAUST GAS TEMPERATURE SENSOR ABGASTEMPERATUR

PRODUCT	MODEL	ENGINE	FUEL	YEAR	POSITION
9589	AUDI	 2.7 TDI 3.0 TDI	 DIESEL DIESEL	 07/12 09/12	 POST TURBO POST TURBO
	A4				
	#OEM 059.906.088.P				
	VOLKSWAGEN	3.0 V6 TDI	DIESEL	07/	PRE TURBO
	TOUAREG				
	#OEM 059.906.088.P				





PRODUCT	MODEL	ENGINE	FUEL	YEAR	POSITION
9590	MERCEDES-BENZ	 G280 CDI G300 CDI	 DIESEL DIESEL	 09/ 10/	 PRE TURBO PRE TURBO
	G-CLASS				
	VITO	122 CDI	DIESEL	10/	PRE TURBO
	SPRINTER 3T	218 CDI 219 CDI	DIESEL DIESEL	06/09 09/	PRE TURBO PRE TURBO
	SPRINTER 3,5T	318 CDI 319 CDI	DIESEL DIESEL	08/09 09/	PRE TURBO PRE TURBO
	SPRINTER 4,6T	418 CDI 419 CDI	DIESEL DIESEL	06/09 09/	PRE TURBO PRE TURBO
	SPRINTER 5T	518 CDI 519 CDI	DIESEL DIESEL	06/09 09/	PRE TURBO PRE TURBO
	#OEM 000.905.33.00 - 000.905.14.05				





EGTS SENSOR





PT200



EXHAUST GAS TEMPERATURE SENSOR ABGASTEMPERATUR

PRODUCT	MODEL	ENGINE	FUEL	YEAR	POSITION
	9591				
	AUDI				
	Q7	3.0 TDI	DIESEL	09/12	PRE CAT
	#OEM 059906088AA				
VOLKSWAGEN					
TOUAREG	3.0 TDI	DIESEL	09/12	PRE CAT	
#OEM 059906088AA					

PRODUCT	MODEL	ENGINE	FUEL	YEAR	POSITION
	9592				
	MERCEDES-BENZ				
	E-CLASS	E320 3.0 V6 CDI	DIESEL	07/09	PRE DPF
	R-CLASS	R320 3.0 V6 CDI	DIESEL	07/09	PRE DPF
#OEM 005.153.45.28					

PRODUCT	MODEL	ENGINE	FUEL	YEAR	POSITION
	9593				
	GM-CHEVROLET				
	SILVERADO 2500 HD	6.6 V8	DIESEL	11/15	PRE DPF
	SILVERADO 3500 HD	6.6 V8	DIESEL	11/15	PRE DPF
	#OEM 12636612				
	GMC				
SIERRA 2500 HD	6.6 V8	DIESEL	11/15	PRE DPF	
SIERRA 3500 HD	6.6 V8	DIESEL	11/15	PRE DPF	
#OEM 12636612					

EGTS SENSOR

PT200



EXHAUST GAS TEMPERATURE SENSOR ABGASTEMPERATUR

PRODUCT	MODEL	ENGINE	FUEL	YEAR	POSITION
9594	PORSCHE CAYENNE #OEM 059.906.088.BR	 3.0 D	 DIESEL	 11/	 PRE DPF
	VOLKSWAGEN TOUAREG #OEM 059.906.088.BR	3.0 V6 TDI CJMA/CRCA	DIESEL	07/18	PRE DPF

PRODUCT	MODEL	ENGINE	FUEL	YEAR	POSITION
9595	VOLKSWAGEN TOUAREG #OEM 059.906.088.BR	 3.0 V6 TDI	 DIESEL	 13/16	 PRE CAT

PRODUCT	MODEL	ENGINE	FUEL	YEAR	POSITION
9596	AUDI Q7 #OEM 059.906.088.AC	 3.0 V6 TDI	 DIESEL	 09/16	 POST DPF
	VOLKSWAGEN TOUAREG #OEM 059.906.088.AC	3.0 V6 TDI	DIESEL	09/10	POST DPF

EGTS SENSOR

PT200



EXHAUST GAS TEMPERATURE SENSOR ABGASTEMPERATUR

PRODUCT	MODEL	ENGINE	FUEL	YEAR	POSITION
 <p>9597</p>	AUDI				
	A3	1.9 TDI 2.0 TDI	DIESEL DIESEL	03/10 04/13	PRE TURBO POST TURBO
	#OEM 03L.906.088.BS 03G.906.088.J				
	SEAT				
	ALTEA	1.9 TDI 2.0 TDI	DIESEL DIESEL	04/ 05/	PRE TURBO PRE TURBO
	ALTEA XL	1.9 TDI 2.0 TDI	DIESEL DIESEL	06/ 06/	PRE TURBO PRE TURBO
	IBIZA V	1.9 TDI	DIESEL	07/	PRE TURBO
	LEON	1.9 TDI 2.0 TDI	DIESEL DIESEL	05/10 05/12	PRE TURBO PRE TURBO
	TOLEDO III	1.9 TDI 2.0 TDI	DIESEL DIESEL	04/09 05/09	PRE TURBO PRE TURBO
	#OEM 03G.906.088.AM				
	SKODA				
	FABIA II	1.9 TDI	DIESEL	07/10	PRE TURBO
	OCTAVIA	1.9 TDI 2.0 TDI	DIESEL DIESEL	04/10 05/10	PRE TURBO PRE TURBO
	OCTAVIA II	1.9 TDI 2.0 TDI	DIESEL DIESEL	04/10 04/13	PRE TURBO PRE TURBO
	ROOMSTER	1.9 TDI	DIESEL	06/10	PRE TURBO
	SUPERB II	1.9 TDI 2.0 TDI	DIESEL DIESEL	08/10 09/15	PRE TURBO PRE TURBO
	YETI	2.0 TDI	DIESEL	09/	PRE TURBO
	#OEM 03G.906.088.AN				

CONTINUING...

EGTS SENSOR

PT200



EXHAUST GAS TEMPERATURE SENSOR ABGASTEMPERATUR

PRODUCT	MODEL	ENGINE	FUEL	YEAR	POSITION
9597 	VOLKSWAGEN				
	CADDY III	1.9 TDI 2.0 TDI	DIESEL DIESEL	04/10 07/10	PRE TURBO PRE TURBO
	EOS	2.0 TDI	DIESEL	06/08	PRE TURBO
	GOLF V	1.9 TDI 2.0 TDI	DIESEL DIESEL	04/09 04/09	PRE TURBO PRE TURBO
	GOLF VI	2.0 TDI	DIESEL	09/12	PRE TURBO
	GOLF PLUS	1.9 TDI 2.0 TDI	DIESEL DIESEL	05/09 05/10	PRE TURBO PRE TURBO
	JETTA III	1.9 TDI 2.0 TDI	DIESEL DIESEL	05/10 05/10	PRE TURBO PRE TURBO
	PASSAT	1.9 TDI 2.0 TDI	DIESEL DIESEL	05/09 05/10	PRE TURBO PRE TURBO
	PASSAT CC	2.0 TDI	DIESEL	05/11	PRE TURBO
	SCIROCCO	2.0 TDI	DIESEL	09/	PRE TURBO
	TIGUAN	2.0 TDI	DIESEL	07/	PRE TURBO
	TOURAN	1.9 TDI 2.0 TDI	DIESEL DIESEL	03/10 05/10	PRE TURBO PRE TURBO

#OEM 03G.906.088.AT

PRODUCT	MODEL	ENGINE	FUEL	YEAR	POSITION
9598 	AUDI				
	Q7	3.0 TDI	DIESEL	06/15	PRE DPF
	VOLKSWAGEN				
	TOUAREG	3.0 TDI 3.0 V6 TDI	DIESEL DIESEL	06/10 10/	PRE DPF PRE DPF

#OEM 059.906.088.S

EGTS SENSOR

PT200



EXHAUST GAS TEMPERATURE SENSOR ABGASTEMPERATUR

PRODUCT	MODEL	ENGINE	FUEL	YEAR	POSITION
9599 	VOLKSWAGEN				
	PASSAT	1.6 TDI	DIESEL	09/14	POST DPF
	MULTIVAN T5	2.5 TDI	DIESEL	03/09	POST DPF
	TRANSPORTER T5	2.5 TDI	DIESEL	03/09	POST DPF
#OEM 070.906.088.AF					

PRODUCT	MODEL	ENGINE	FUEL	YEAR	POSITION	
9600 	SEAT					
	CORDOBA	1.4 TDI	DIESEL	05/09	PRE TURBO	
		1.9 TDI	DIESEL	02/09	PRE TURBO	
	EXEO	2.0 TDI	DIESEL	08/	PRE DPF	
	EXEO ST	2.0 TDI	DIESEL	09/	PRE DPF	
	IBIZA IV	1.4 TDI	DIESEL	05/09	PRE TURBO	
		1.9 TDI	DIESEL	02/09	PRE TURBO	
	IBIZA V	1.4 TDI	DIESEL	08/10	PRE TURBO	
	#OEM 045.906.088.J					
	SKODA					
	FABIA II	1.4 TDI	DIESEL	07/10	PRE TURBO	
	ROOMSTER	1.4 TDI	DIESEL	06/10	PRE TURBO	
#OEM 045.906.088.J						
VOLKSWAGEN						
POLO	1.4 TDI	DIESEL	05/09	PRE TURBO		
	1.9 TDI	DIESEL	01/09	PRE TURBO		
#OEM 045.906.088.J						

OBS.: FOR LEFT-HAND DRIVE VEHICLES.

EGTS SENSOR

PT200



EXHAUST GAS TEMPERATURE SENSOR ABGASTEMPERATUR

PRODUCT	MODEL	ENGINE	FUEL	YEAR	POSITION	
	9601					
	SEAT					
	CORDOBA	1.4 TDI	DIESEL	05/09	PRE TURBO	
	IBIZA IV	1.4 TDI 1.9 TDI	DIESEL DIESEL	05/09 02/09	PRE TURBO PRE TURBO	
	IBIZA V	1.4 TDI 1.9 TDI	DIESEL DIESEL	08/10 08/10	PRE TURBO PRE TURBO	
	#OEM 045.906.088.G					
	SKODA					
	FABIA II	1.4 TDI	DIESEL	07/10	PRE TURBO	
	ROOMSTER	1.4 TDI	DIESEL	06/10	PRE TURBO	
	#OEM 045.906.088.G					
	VOLKSWAGEN					
	POLO	1.9 TDI	DIESEL	01/09	PRE TURBO	
	#OEM 045.906.088.G					

OBS.: FOR LEFT-HAND DRIVE VEHICLES.

PRODUCT	MODEL	ENGINE	FUEL	YEAR	POSITION	
	9602					
	VOLKSWAGEN					
	MULTIVAN T5	2.0 TDI	DIESEL	09/15	PRE DPF	
	TRANSPORTER T5	2.0 TDI	DIESEL	09/15	PRE DPF	
	MULTIVAN T6	2.0 TDI	DIESEL	15/	PRE DPF	
	TRANSPORTER T6	2.0 TDI	DIESEL	15/	PRE DPF	
#OEM 03L.906.088.DF - 03L.906.088.DP - 03L.906.088.HG - 03L.906.088.FF						

EGTS SENSOR

PT200



EXHAUST GAS TEMPERATURE SENSOR ABGASTEMPERATUR

PRODUCT	MODEL	ENGINE	FUEL	YEAR	POSITION
9603 	AUDI				
	A3	2.0 TDI	DIESEL	12/	PRE TURBO
	TT	2.0 TDI	DIESEL	14/	PRE TURBO
	#OEM 04L.906.088 04L.906.088.AE				
	SEAT				
	LEON	2.0 TDI	DIESEL	12/	PRE TURBO
	#OEM 04L.906.088 04L.906.088.AE				
	VOLKSWAGEN				
	GOLF VII	2.0 TDI	DIESEL	12/	PRE TURBO
	PASSAT	2.0 TDI	DIESEL	14/	PRE TURBO
TOURAN	2.0 TDI	DIESEL	15/	PRE TURBO	
#OEM 04L.906.088 - 04L.906.088.AE					

PRODUCT	MODEL	ENGINE	FUEL	YEAR	POSITION
9604 	VOLVO				
	S40 II	2.4 D5	DIESEL	06/10	POST DPF
	V50	2.4 TDI	DIESEL	07/10	POST DPF
	V51	2.4 D5	DIESEL	06/10	POST DPF
#OEM 31293032 - 31431047					

EGTS SENSOR

PT200



EXHAUST GAS TEMPERATURE SENSOR ABGASTEMPERATUR

PRODUCT	MODEL	ENGINE	FUEL	YEAR	POSITION
 <p>9605</p>	AUDI				
	A3	1.6 TDI	DIESEL	12/	PRE DPF
	#OEM 04L.906.088.E				
	SEAT				
	LEON	1.6 TDI	DIESEL	12/	PRE DPF
	LEON SC	1.6 TDI	DIESEL	13/	PRE DPF
	LEON ST	1.6 TDI	DIESEL	14/	PRE DPF
	#OEM 04L.906.088.E				
	SKODA				
	OCTAVIA III	1.6 TDI	DIESEL	12/	PRE DPF
#OEM 04L.906.088.E					
VOLKSWAGEN					
GOLF VII	1.6 TDI	DIESEL	12/	PRE DPF	
#OEM 04L.906.088.E					





PRODUCT	MODEL	ENGINE	FUEL	YEAR	POSITION
 <p>9606</p>	AUDI				
	A6	2.7 TDI 3.0 TDI	DIESEL DIESEL	04/11 05/11	PRE DPF PRE DPF
#OEM 059.906.088.AE					





EGTS SENSOR

PT200



EXHAUST GAS TEMPERATURE SENSOR ABGASTEMPERATUR

PRODUCT	MODEL	ENGINE	FUEL	YEAR	POSITION
9607 	AUDI	 2.0 TDI 1.9 TDI	 DIESEL DIESEL	 04/09 04/08	 PRE TURBO PRE TURBO
	A4 #OEM 03G.906.088.AK 038.906.088.C 038.906.088.E				
	SKODA	2.0 TDI	DIESEL	05/08	PRE TURBO
	SUPERB I #OEM 03G.906.088.AK				

PRODUCT	MODEL	ENGINE	FUEL	YEAR	POSITION
9608 	SEAT	 1.2 TDI	 DIESEL	 10/	 PRE DPF
	IBIZA #OEM 03P.906.088.E				
	SKODA	1.2 TDI	DIESEL	10/14	PRE DPF
	FABIA II	1.2 TDI	DIESEL	10/15	PRE DPF
	ROOMSTER #OEM 03P.906.088.C				
	VOLKSWAGEN	1.2 TDI	DIESEL	09/	PRE DPF
	POLO #OEM 03P.906.088.C				

EGTS SENSOR

PT200



EXHAUST GAS TEMPERATURE SENSOR ABGASTEMPERATUR

PRODUCT	MODEL	ENGINE	FUEL	YEAR	POSITION
9609 	SEAT				
	CORDOBA	1.4 TDI 1.9 TDI	DIESEL DIESEL	05/09 02/09	POST DPF POST DPF
	IBIZA IV	1.4 TDI 1.9 TDI	DIESEL DIESEL	05/09 02/09	POST DPF POST DPF
	IBIZA V	1.4 TDI	DIESEL	08/10	POST DPF
	#OEM 045.906.088.F				
	SKODA				
	FABIA II	1.4 TDI	DIESEL	07/10	POST DPF
	ROOMSTER	1.4 TDI	DIESEL	06/10	POST DPF
	#OEM 045.906.088.F				
	VOLKSWAGEN				
POLO	1.4 TDI 1.9 TDI	DIESEL DIESEL	05/09 01/09	POST DPF POST DPF	
#OEM 045.906.088.F					





PRODUCT	MODEL	ENGINE	FUEL	YEAR	POSITION
9610 	VOLKSWAGEN				
	TOUAREG	2.5 TDI	DIESEL	03/10	PRE TURBO
	MULTIVAN T5	2.5 TDI	DIESEL	03/09	PRE TURBO
	TRANSPORTER T5	2.5 TDI	DIESEL	03/09	PRE TURBO
#OEM 070.906.088.AC					





EGTS SENSOR





PT200



EXHAUST GAS TEMPERATURE SENSOR ABGASTEMPERATUR

PRODUCT	MODEL	ENGINE	FUEL	YEAR	POSITION
9611 	AUDI				
	A4	2.0 TDI	DIESEL	07/15	POST DPF
	A5	2.0 TDI	DIESEL	08/17	POST DPF
	Q5	2.0 TDI	DIESEL	08/	POST DPF
#OEM 03L.906.088.E					

PRODUCT	MODEL	ENGINE	FUEL	YEAR	POSITION
9612 	VOLKSWAGEN				
	CADDY III	1.6 TDI	DIESEL	10/15	POST DPF
	TOURAN	1.6 TDI	DIESEL	10/15	POST DPF
#OEM 03L.906.088.AT					

PRODUCT	MODEL	ENGINE	FUEL	YEAR	POSITION	
9613 	MERCEDES-BENZ					
	C-CLASS	C 350 CDI CLS 320 CDI CLS 350 CDI CLS 350 BlueTec	DIESEL DIESEL DIESEL DIESEL	11/14 05/10 09/10 12/	PRE CAT PRE CAT PRE CAT PRE CAT	
	E-CLASS	E 280 CDI E 300 CDI E 350 BlueTec	DIESEL DIESEL DIESEL	05/09 09/10 09/	PRE CAT PRE CAT PRE CAT	
	S-CLASS	S 350 CGI	DIESEL	11/13	PRE CAT	
	#OEM 000.905.90.00 - 007.153.88.28 - 005.153.90.28					





CONTINUING...

EGTS SENSOR





PT200



EXHAUST GAS TEMPERATURE SENSOR ABGASTEMPERATUR

PRODUCT	MODEL	ENGINE	FUEL	YEAR	POSITION				
9613 	MERCEDES-BENZ M-CLASS								
						ML 280 CDI	DIESEL	05/09	PRE CAT
						ML 300 CDI	DIESEL	09/11	PRE CAT
						ML 320 CDI	DIESEL	05/09	PRE CAT
						ML 350 CDI	DIESEL	09/11	PRE CAT
	GL-CLASS	GL 320 CDI	DIESEL	09/10	PRE CAT				
		GL 350 CDI	DIESEL	10/10	PRE CAT				

#OEM 000.905.90.00 - 007.153.88.28 - 005.153.90.28

PRODUCT	MODEL	ENGINE	FUEL	YEAR	POSITION
9614 	MERCEDES-BENZ C-CLASS				
	E-CLASS	C 220 CDI	DIESEL	07/08	PRE DPF
		E 200 CDI	DIESEL	02/08	POST CAT
		E 220 CDI	DIESEL	02/08	POST CAT
	SPRINTER 3-T	E 420 CDI	DIESEL	06/08	PRE DPF
		209 CDI	DIESEL	06/09	PRE CAT
		210 CDI	DIESEL	09/13	PRE CAT
		211 CDI	DIESEL	06/09	PRE CAT
		213 CDI	DIESEL	06/16	PRE CAT
		216 CDI	DIESEL	06/09	PRE CAT
		218 CDI	DIESEL	09/09	PRE CAT
	SPRINTER 3,5-T	219 CDI	DIESEL	09/09	PRE CAT
		309 CDI	DIESEL	06/09	PRE CAT
		310 CDI	DIESEL	09/13	PRE CAT
		311 CDI	DIESEL	08/09	PRE CAT
		313 CDI	DIESEL	11/16	PRE CAT
		315 CDI	DIESEL	08/09	PRE CAT
		316 CDI	DIESEL	11/09	PRE CAT
		318 CDI	DIESEL	08/09	PRE DPF
	SPRINTER 4,6-T	319 CDI	DIESEL	09/09	PRE DPF
		415 CDI	DIESEL	06/09	PRE CAT
	SPRINTER 5-T	419 CDI	DIESEL	09/09	PRE DPF
		509 CDI	DIESEL	06/09	PRE CAT
		510 CDI	DIESEL	09/16	PRE CAT
		511 CDI	DIESEL	06/09	PRE CAT
		513 CDI	DIESEL	06/09	PRE CAT
		515 CDI	DIESEL	06/09	PRE CAT
516 CDI		DIESEL	09/09	PRE CAT	
518 CDI		DIESEL	06/09	PRE CAT	
519 CDI		DIESEL	09/09	PRE DPF	





#OEM 000.905.56.08 - 000.905.88.04 - 005.153.22.28 - 007.153.34.28 - 007.153.95.28

EGTS SENSOR





PT200







EXHAUST GAS TEMPERATURE SENSOR ABGASTEMPERATUR

PRODUCT	MODEL	ENGINE	FUEL	YEAR	POSITION				
 <p>9615</p>	VOLKSWAGEN								
	CRAFTER 30-35					2.0 TDI	DIESEL	11/16	PRE TURBO
	CRAFTER 30-50					2.0 TDI	DIESEL	11/16	PRE TURBO
	MULTIVAN T5					2.0 TDI	DIESEL	09/15	PRE TURBO
	MULTIVAN T6					2.0 TDI	DIESEL	15/	PRE TURBO
	TRANSPORTER T5					2.0 TDI	DIESEL	09/15	PRE TURBO
	TRANSPORTER T6					2.0 TDI	DIESEL	15/	PRE TURBO

#OEM 03L.906.088.FB - 03L.906.088.DC

PRODUCT	MODEL	ENGINE	FUEL	YEAR	POSITION				
 <p>9616</p>	VOLKSWAGEN								
	CRAFTER 30-35					2.5 TDI	DIESEL	06/13	PRE TURBO
	CRAFTER 30-50					2.5 TDI	DIESEL	06/13	PRE TURBO

#OEM 070.906.088

PRODUCT	MODEL	ENGINE	FUEL	YEAR	POSITION					
 <p>9618</p>	AUDI									
	A1					1.6 TDI	DIESEL	10/	PRE DPF	
	#OEM 03L.906.088.P									
	SEAT									
	IBIZA V					1.6 TDI	DIESEL	09/	PRE DPF	
TOLEDO IV	1.6 TDI	DIESEL	12/	PRE DPF						

#OEM 03L.906.088.FG

CONTINUING...

EGTS SENSOR

PT200



EXHAUST GAS TEMPERATURE SENSOR ABGASTEMPERATUR

PRODUCT	MODEL	ENGINE	FUEL	YEAR	POSITION
9618 	SKODA				
	FABIA II	1.2 TDI 1.6 TDI	DIESEL DIESEL	10/14 10/14	PRE DPF PRE DPF
	RAPID	1.6 TDI	DIESEL	12/	PRE DPF
	ROOMSTER	1.2 TDI 1.6 TDI	DIESEL DIESEL	10/15 10/15	PRE DPF PRE DPF
	#OEM 03L.906.088.P				
VOLKSWAGEN					
	POLO	1.6 TDI	DIESEL	09/	PRE DPF
#OEM 03L.906.088.FG					





PRODUCT	MODEL	ENGINE	FUEL	YEAR	POSITION
9619 	VOLKSWAGEN				
	MULTIVAN T5	2.0 BiTDI	DIESEL	09/15	PRE TURBO
	TRANSPORTER T5	2.0 BiTDI	DIESEL	09/15	PRE TURBO
	MULTIVAN T6	2.0 TDI	DIESEL	15/	PRE TURBO
	TRANSPORTER T6	2.0 TDI	DIESEL	15/	PRE TURBO
#OEM 03L.906.088.DJ					

EGTS SENSOR

PT200







EXHAUST GAS TEMPERATURE SENSOR ABGASTEMPERATUR

PRODUCT	MODEL	ENGINE	FUEL	YEAR	POSITION
9620	VOLKSWAGEN				
	MULTIVAN T5	2.0 TDI	DIESEL	09/15	PRE CAT
	TRANSPORTER T5	2.0 TDI	DIESEL	09/15	PRE CAT





#OEM 03L.906.088.BN



PRODUCT	MODEL	ENGINE	FUEL	YEAR	POSITION
9621	VOLKSWAGEN				
	MULTIVAN T5	2.0 TDI	DIESEL	09/15	PRE DPF
	TRANSPORTER T5	2.0 TDI	DIESEL	09/15	PRE DPF
	MULTIVAN T6	2.0 TDI	DIESEL	15/	PRE DPF
	TRANSPORTER T6	2.0 TDI	DIESEL	15/	PRE DPF

#OEM 03L.906.088.BP



PRODUCT	MODEL	ENGINE	FUEL	YEAR	POSITION
9622	VOLKSWAGEN				
	MULTIVAN T5	2.0 TDI	DIESEL	09/15	POST DPF
	TRANSPORTER T5	2.0 TDI	DIESEL	09/15	POST DPF
	MULTIVAN T6	2.0 TDI	DIESEL	15/	POST DPF
	TRANSPORTER T6	2.0 TDI	DIESEL	15/	POST DPF

#OEM 03L.906.088.BQ - 03L.906.088.HK













EGTS SENSOR





PT200



EXHAUST GAS TEMPERATURE SENSOR ABGASTEMPERATUR

PRODUCT	MODEL	ENGINE	FUEL	YEAR	POSITION
9623 	VOLKSWAGEN				
	MULTIVAN T5	1.9 TDI	DIESEL	06/09	PRE DPF
	TRANSPORTER T5	1.9 TDI	DIESEL	06/09	PRE DPF
#OEM 036.906.088.AQ					

PRODUCT	MODEL	ENGINE	FUEL	YEAR	POSITION
9624 	VOLKSWAGEN				
	CRAFTER 30-35	2.5 TDI	DIESEL	06/13	POST DPF
	CRAFTER 30-50	2.5 TDI	DIESEL	06/13	POST DPF
#OEM 076.906.088.E					





PRODUCT	MODEL	ENGINE	FUEL	YEAR	POSITION
9625 	VOLKSWAGEN				
	CRAFTER 30-35	2.5 TDI	DIESEL	06/13	PRE TURBO
	CRAFTER 30-50	2.5 TDI	DIESEL	06/13	PRE TURBO
#OEM 076.906.088.C					





EGTS SENSOR





PT200



EXHAUST GAS TEMPERATURE SENSOR ABGASTEMPERATUR

PRODUCT	MODEL	ENGINE	FUEL	YEAR	POSITION
9626 	VOLKSWAGEN				
	MULTIVAN T5	1.9 TDI	DIESEL	06/09	POST DPF
	TRANSPORTER T5	1.9 TDI	DIESEL	06/09	POST DPF
#OEM 03G.906.088.AR					

PRODUCT	MODEL	ENGINE	FUEL	YEAR	POSITION
9627 	VOLKSWAGEN				
	MULTIVAN T5	2.5 TDI	DIESEL	04/09	POST DPF
	TRANSPORTER T5	2.5 TDI	DIESEL	04/09	POST DPF
#OEM 070.906.088.AE					









PRODUCT	MODEL	ENGINE	FUEL	YEAR	POSITION
9628 	SEAT				
	ALHAMBRA	2.0 TDI	DIESEL	05/10	PRE DPF
	#OEM 03G.906.088.E				
VOLKSWAGEN	SHARAN	2.0 TDI	DIESEL	05/10	PRE DPF
#OEM 076.906.088.C					

EGTS SENSOR

PT200



EXHAUST GAS TEMPERATURE SENSOR ABGASTEMPERATUR

PRODUCT	MODEL	ENGINE	FUEL	YEAR	POSITION
9629	AUDI	 2.7 TDI 3.0 TDI	 DIESEL DIESEL	 07/12 07/12	 POST DPF POST DPF
	A4				
9630	AUDI	 2.7 TDI 3.0 TDI	 DIESEL DIESEL	 05/09 04/09	 PRE DPF PRE DPF
	A4				







AUDI

A4

A5

#OEM 059.906.088.Q

PRODUCT	MODEL	ENGINE	FUEL	YEAR	POSITION
9630	AUDI	 2.7 TDI 3.0 TDI	 DIESEL DIESEL	 05/09 04/09	 PRE DPF PRE DPF
	A4				



AUDI

A4

#OEM 059.906.088.H

EGTS SENSOR

PT200



EXHAUST GAS TEMPERATURE SENSOR ABGASTEMPERATUR

PRODUCT	MODEL	ENGINE	FUEL	YEAR	POSITION
 <p>9631</p>	AUDI				
	A3	1.6 FSI 2.0 FSI 2.0 16V TDI	DIESEL DIESEL DIESEL	03/07 03/08 03/12	PRE DPF PRE DPF PRE DPF
	#OEM 06F.906.088.D				
	SKODA				
	OCTAVIA II	2.0 FSI	DIESEL	04/08	PRE DPF
	#OEM 06F.906.088.D				
VOLKSWAGEN					
TOURAN	2.0 FSI	DIESEL	03/07	PRE CAT	
#OEM 06F.906.088.D					

PRODUCT	MODEL	ENGINE	FUEL	YEAR	POSITION
 <p>9632</p>	SKODA				
	SUPERB I	2.0 TDI	DIESEL	05/08	PRE DPF
	#OEM 038.906.088.B				
	VOLKSWAGEN				
PASSAT	2.0 TDI	DIESEL	03/08	PRE DPF	
#OEM 038.906.088.B					

EGTS SENSOR

PT200



EXHAUST GAS TEMPERATURE SENSOR ABGASTEMPERATUR

PRODUCT	MODEL	ENGINE	FUEL	YEAR	POSITION
9633 	SKODA				
	A6	3.0 TDI	DIESEL	14/	PRE TURBO
	A7	3.0 TDI	DIESEL	14/	PRE TURBO
	A8	3.0 TDI	DIESEL	12/	PRE TURBO
	Q5	3.0 TDI	DIESEL	13/	PRE TURBO
	#OEM 059.906.088.CE				
	VOLKSWAGEN				
	TOUAREG	3.0 TDI V6	DIESEL	10/	PRE TURBO
	#OEM 059.906.088.CE				

PRODUCT	MODEL	ENGINE	FUEL	YEAR	POSITION
9634 	AUDI				
	A4	2.7 TDI	DIESEL	07/12	POST TURBO
	A5	2.7 TDI	DIESEL	07/12	PRE TURBO
		3.0 TDI	DIESEL	07/12	PRE TURBO
	#OEM 059.906.088.K				
	VOLKSWAGEN				
	PHAETON	3.0 V6 TDI	DIESEL	08/16	POST TURBO
#OEM 059.906.088.K					

EGTS SENSOR

PT200



EXHAUST GAS TEMPERATURE SENSOR ABGASTEMPERATUR

PRODUCT	MODEL	ENGINE	FUEL	YEAR	POSITION
9635 	AUDI				
	A6	2.7 TDI 3.0 TDI	DIESEL DIESEL	04/11 04/11	POST CAT POST CAT
	A8	3.0 TDI	DIESEL	03/10	POST CAT
	Q7	4.2 TDI	DIESEL	07/09	PRE DPF
#OEM 038.906.088.D					

PRODUCT	MODEL	ENGINE	FUEL	YEAR	POSITION
9636 	AUDI				
	A6	2.7 TDI 3.0 TDI	DIESEL DIESEL	04/11 04/11	PRE DPF PRE DPF
	A8	3.0 TDI 4.2 TDI	DIESEL DIESEL	03/10 05/10	PRE DPF PRE DPF
	#OEM 038.906.088.A				

PRODUCT	MODEL	ENGINE	FUEL	YEAR	POSITION
9637 	AUDI				
	A4	2.0 TDI	DIESEL	06/08	PRE TURBO
#OEM 03G.906.088.AP					

EGTS SENSOR

PT200



EXHAUST GAS TEMPERATURE SENSOR ABGASTEMPERATUR

PRODUCT	MODEL	ENGINE	FUEL	YEAR	POSITION
 <p>9638</p>	AUDI				
	A1	1.6 TDI	DIESEL	10/	PRE DPF
	#OEM 03L.906.088.GR				
	SEAT				
	IBIZA IV	1.2 TDI 1.6 TDI	DIESEL DIESEL	10/ 09/	PRE DPF PRE DPF
	TOLEDO IV	1.6 TDI	DIESEL	12/	PRE DPF
	#OEM 03L.906.088.DE				
	SKODA				
	FABIA II	1.2 TDI 1.6 TDI	DIESEL DIESEL	10/14 10/14	PRE DPF PRE DPF
	ROOMSTER	1.2 TDI 1.6 TDI	DIESEL DIESEL	10/15 10/15	PRE DPF PRE DPF
	#OEM 03L.906.088.GR				
	VOLKSWAGEN				
POLO	1.2 TDI 1.6 TDI	DIESEL DIESEL	09/ 09/	PRE DPF PRE DPF	
#OEM 04L.906.088.E					

EGTS SENSOR

PT200



EXHAUST GAS TEMPERATURE SENSOR ABGASTEMPERATUR

PRODUCT	MODEL	ENGINE	FUEL	YEAR	POSITION
9639 	MERCEDES-BENZ				
	A CLASS	A180 CDI A200 CDI A220 CDI	DIESEL DIESEL DIESEL	12/ 12/ 12/	PRE DPF PRE DPF PRE DPF
	B CLASS	B160 CDI B180 CDI B200 CDI B220 CDI	DIESEL DIESEL DIESEL DIESEL	13/ 13/ 14/ 14/	PRE CAT PRE CAT PRE CAT PRE CAT
	CLS CLASS	CLS350 CDI	DIESEL	12/	POST DPF
	E CLASS	E200 CDI E220 CDI E250 CDI E300 CDI E350 CDI	DIESEL DIESEL DIESEL DIESEL DIESEL	09/ 09/ 11/ 11/ 09/	POST DPF POST DPF POST DPF POST DPF POST DPF

#OEM 000.905.07.01 - 000.905.70.04 - 000.905.85.01

PRODUCT	MODEL	ENGINE	FUEL	YEAR	POSITION
9640 	MERCEDES-BENZ				
	A CLASS	A180 CDI A200 CDI	DIESEL DIESEL	04/12 04/12	PRE TURBO PRE TURBO
	B CLASS	B180 CDI B200 CDI	DIESEL DIESEL	05/11 05/11	PRE TURBO PRE TURBO
	G CLASS	G320 CDI	DIESEL	06/	PRE TURBO

#OEM 007.153.92.28 - 008.153.28.28

EGTS SENSOR

PT200



EXHAUST GAS TEMPERATURE SENSOR ABGASTEMPERATUR

PRODUCT	MODEL	ENGINE	FUEL	YEAR	POSITION
 <p>9641</p>	MERCEDES-BENZ				
	CLS	CLS 350	DIESEL	12/	PRE CAT
	SPRINTER 3-t	209 CDI	DIESEL	06/09	PRE CAT
		211 CDI	DIESEL	06/09	PRE CAT
		213 CDI	DIESEL	06/09	PRE CAT
		215 CDI	DIESEL	06/09	PRE CAT
		216 CDI	DIESEL	09/	PRE CAT
		218 CDI	DIESEL	06/09	PRE CAT
		219 CDI	DIESEL	06/09	PRE CAT
	SPRINTER 3,5-t	309 CDI	DIESEL	06/09	FOR CAT
		311 CDI	DIESEL	06/09	FOR CAT
		315 CDI	DIESEL	08/09	FOR CAT
		318 CDI	DIESEL	08/09	FOR CAT
		319 CDI	DIESEL	09/	FOR CAT
	SPRINTER 4,6-t	415 CDI	DIESEL	06/09	FOR CAT
SPRINTER 5-t	509 CDI	DIESEL	06/09	FOR CAT	
	511 CDI	DIESEL	06/09	FOR CAT	
	515 CDI	DIESEL	06/09	FOR CAT	
	518 CDI	DIESEL	06/09	FOR CAT	

#OEM 000.905.87.00

PRODUCT	MODEL	ENGINE	FUEL	YEAR	POSITION
 <p>9642</p>	MERCEDES-BENZ				
	ML CLASS	420 CDI	DIESEL	06/09	PRE TURBO
		450 CDI	DIESEL	09/11	PRE TURBO
	GL CLASS	420 CDI	DIESEL	06/09	PRE TURBO
		450 CDI	DIESEL	09/	PRE TURBO





#OEM 007.153.86.28

EGTS SENSOR

PT200







EXHAUST GAS TEMPERATURE SENSOR ABGASTEMPERATUR

PRODUCT	MODEL	ENGINE	FUEL	YEAR	POSITION
9643	MERCEDES-BENZ C CLASS	 C 220 BlueTec C 250 Blue Tec C 300 Blue Tec	 DIESEL DIESEL DIESEL	 14/ 14/ 14/	 FOR CAT FOR CAT FOR CAT

#OEM 001.905.29.00



PRODUCT	MODEL	ENGINE	FUEL	YEAR	POSITION
9644	MERCEDES-BENZ CLC-CLASS	 CLC 200 CDI CLC 220 CDI	 DIESEL DIESEL	 08/11 08/11	 PRE DPF PRE DPF
	S-CLASS	S 320 CDI	DIESEL	02/05	PRE CAT
	M-CLASS	ML 280 CDI ML 300 CDI ML 320 CDI	DIESEL DIESEL DIESEL	05/09 09/11 05/09	FOR DPF FOR DPF FOR DPF
	R-CLASS	R 280 CDI R 300 CDI R 320 CDI R 350 CDI	DIESEL DIESEL DIESEL DIESEL	06/ 09/ 06/ 06/	FOR DPF FOR DPF FOR DPF FOR DPF
	G-CLASS	G 350 CDI	DIESEL	11/	PRE DPF
	GL-CLASS	GL 320 CDI GL 350 CDI	DIESEL DIESEL	06/ 09/	PRE DPF PRE DPF

#OEM 005.153.42.28 - 007.153.76.28 - 007.153.84.28



EGTS SENSOR

PT200



EXHAUST GAS TEMPERATURE SENSOR ABGASTEMPERATUR

PRODUCT	MODEL	ENGINE	FUEL	YEAR	POSITION
9645 	OPEL				
	ASTRA H	1.9 CDTI 1.9 16V CDTI	DIESEL DIESEL	04/10 04/10	PRE CAT PRE CAT
	SIGNUM	1.9 CDTI	DIESEL	04/08	PRE CAT
	VECTRA C	1.9 CDTI	DIESEL	04/09	PRE CAT
	ZAFIRA B	1.9 CDTI	DIESEL	05/15	PRE CAT

#OEM 55355404 - 855410

PRODUCT	MODEL	ENGINE	FUEL	YEAR	POSITION
9646 	FIAT				
	CROMA	1.9 D Multijet	DIESEL	05/	PRE DPF
	GRANDE PUNTO	1.9 D Multijet	DIESEL	05/	PRE DPF

#OEM 55200036 - 55200037 - 552000360

PRODUCT	MODEL	ENGINE	FUEL	YEAR	POSITION
9647 	OPEL				
	ASTRA H	1.9 CDTI 1.9 16V CDTI	DIESEL DIESEL	04/10 04/10	POST CAT POST DPF
	ZAFIRA B	1.9 CDTI	DIESEL	05/15	POST DPF





#OEM 55558578 - 855412





EGTS SENSOR

PT200



EXHAUST GAS TEMPERATURE SENSOR ABGASTEMPERATUR

PRODUCT	MODEL	ENGINE	FUEL	YEAR	POSITION
9648 	FIAT DOBLO #OEM 55212786 51807903	 1.3 D Multijet 1.9 D Multijet 1.3 JTD Multijet 1.9 JTD Multijet	 DIESEL DIESEL DIESEL DIESEL	 05/ 05/ 06/ 06/	 POST DPF POST DPF POST DPF POST DPF
	LANCIA DELTA III #OEM 55199054	1.6 D Multijet 1.9 D Multijet 2.0 D Multijet	DIESEL DIESEL DIESEL	08/14 09/14 08/14	PRE DPF PRE CAT PRE DPF





PRODUCT	MODEL	ENGINE	FUEL	YEAR	POSITION
9649 	VOLKSWAGEN PHAETON #OEM 059.906.088.AD	 3.0 V6 TDI	 DIESEL	 04/16	 POST CAT

EGTS SENSOR





PT200



EXHAUST GAS TEMPERATURE SENSOR ABGASTEMPERATUR

PRODUCT	MODEL	ENGINE	FUEL	YEAR	POSITION					
 <p>9650</p>	<p>MERCEDES-BENZ</p>									
						E-CLASS	280 CDI 320 CDI 280 T CDI 320 T CDI	DIESEL DIESEL DIESEL DIESEL	05/08 05/08 05/09 05/09	FOR CAT FOR CAT FOR CAT FOR CAT
						S-CLASS	320 CDI	DIESEL	05/13	FOR CAT
						R-CLASS	280 CDI 300 CDI	DIESEL DIESEL	06/ 09/	FOR CAT FOR CAT
						G-CLASS	320 CDI	DIESEL	06/	POST CAT
						GL-CLASS	320 CDI 350 CDI	DIESEL DIESEL	06/09 09/	FOR CAT FOR CAT
						VITO	110 CDI 113 CDI 116 CDI 122 CDI	DIESEL DIESEL DIESEL DIESEL	10/ 10/ 10/ 10/	PRE CAT PRE CAT PRE CAT PRE CAT

#OEM 007.153.96.28

PRODUCT	MODEL	ENGINE	FUEL	YEAR	POSITION					
 <p>9651</p>	<p>MERCEDES-BENZ</p>									
						M-CLASS	ML 250 CDI ML 350 BlueTec	DIESEL DIESEL	11/15 11/15	FOR DPF FOR DPF
						GLE	250 d 350 d	DIESEL DIESEL	15/ 15/	PRE DPF POST DPF
						GL-CLASS	350 CDI 350 BlueTec	DIESEL DIESEL	10/ 12/	PRE DPF POST DPF





#OEM 000.905.71.04 - 001.905.23.00





EGTS SENSOR





PT200



EXHAUST GAS TEMPERATURE SENSOR ABGASTEMPERATUR

PRODUCT	MODEL	ENGINE	FUEL	YEAR	POSITION
9652 	MERCEDES-BENZ				
	M-CLASS	ML 250 CDI ML 350 BlueTec	DIESEL DIESEL	11/15 11/15	PRE DPF PRE DPF
	GLE	350 d	DIESEL	15/	PRE DPF
	GL-CLASS	350 CDI	DIESEL	12/	FOR CAT
#OEM 000.905.69.04					

PRODUCT	MODEL	ENGINE	FUEL	YEAR	POSITION
9653 	VOLKSWAGEN				
	AMAROK	2.0 BitDI	DIESEL	10/	PRE TURBO
#OEM 3L.906.088.CQ					





PRODUCT	MODEL	ENGINE	FUEL	YEAR	POSITION
9654 	VOLKSWAGEN				
	AMAROK	2.0 TDI	DIESEL	10/	PRE TURBO
#OEM 3L.906.088.EK					

EGTS SENSOR

PT200







EXHAUST GAS TEMPERATURE SENSOR ABGASTEMPERATUR

PRODUCT	MODEL	ENGINE	FUEL	YEAR	POSITION
9655	AUDI				
	A8	4.2 TDI	DIESEL	09/	PRE DPF
	Q7	3.0 TDI 3.0 TDI	DIESEL DIESEL	07/15 11/15	POST CAT PRE DPF





#OEM 4H0.906.088.F



PRODUCT	MODEL	ENGINE	FUEL	YEAR	POSITION
9656	AUDI				
	A8	4.2 TDI	DIESEL	09/	PRE TURBO

#OEM 057.906.088.D



PRODUCT	MODEL	ENGINE	FUEL	YEAR	POSITION
9657	AUDI				
	Q7	4.2 TDI 6.0 TDI	DIESEL DIESEL	07/15 08/14	PRE DPF PRE CAT

#OEM 057.906.088.B







EGTS SENSOR

PT200



EXHAUST GAS TEMPERATURE SENSOR ABGASTEMPERATUR

PRODUCT	MODEL	ENGINE	FUEL	YEAR	POSITION
9658	MERCEDES-BENZ				
	M-CLASS				
	GL-CLASS	GL 420 CDI GL 450 CDI	DIESEL DIESEL	06/09 09/	POST DPF POST DPF



MERCEDES-BENZ

M-CLASS

ML 420 CDI
ML 450 CDI

DIESEL
DIESEL

06/09
09/11

POST DPF
POST DPF

GL-CLASS





GL 420 CDI
GL 450 CDI

DIESEL
DIESEL

06/09
09/

POST DPF
POST DPF

#OEM 007.153.65.28

PRODUCT	MODEL	ENGINE	FUEL	YEAR	POSITION
9659	VOLKSWAGEN				
	PASSAT				



VOLKSWAGEN

PASSAT





2.0 TDI

DIESEL

12/14

POST DPF

#OEM 03L.906.088.ES

PRODUCT	MODEL	ENGINE	FUEL	YEAR	POSITION
9660	VOLKSWAGEN				
	TOUAREG				



VOLKSWAGEN

TOUAREG

2.5 R5 TDI

DIESEL

03/10

PRE DPF





#OEM 070.906.088.D





EGTS SENSOR





PT200



EXHAUST GAS TEMPERATURE SENSOR ABGASTEMPERATUR

PRODUCT	MODEL	ENGINE	FUEL	YEAR	POSITION
9661					
	MERCEDES-BENZ				
	E-CLASS	E 300 CDI E 350 CDI	DIESEL DIESEL	11/ 11/	PRE CAT PRE CAT
	S-CLASS	S 350 CDI	DIESEL	11/13	PRE CAT
#OEM 000.905.06.32					

PRODUCT	MODEL	ENGINE	FUEL	YEAR	POSITION
9662					
	MERCEDES-BENZ				
	A-CLASS	A 160 CDI	DIESEL	04/12	PRE TURBO
	CLS-CLASS	CLS 250 BlueTec	DIESEL	14/	PRE DPF
	E-CLASS	E-220 BlueTec E 250 CDI	DIESEL DIESEL	15/ 09/	PRE CAT PRE CAT
	S-CLASS	SL 350 SLK 250 CDI	DIESEL DIESEL	12/ 12/	POST CAT PRE CAT
	GLK-CLASS	200 CDI 220 CDI 250 CDI	DIESEL DIESEL DIESEL	13/15 08/15 09/15	PRE CAT PRE CAT PRE CAT
#OEM 000.905.35.05 - 001.905.28.00 - 001.905.27.99					





PRODUCT	MODEL	ENGINE	FUEL	YEAR	POSITION
9663					
	VOLKSWAGEN				
	PASSAT	2.0 TDI	DIESEL	12/14	PRE DPF
#OEM 03L.906.088.EF					





EGTS SENSOR





PT200



EXHAUST GAS TEMPERATURE SENSOR ABGASTEMPERATUR

PRODUCT	MODEL	ENGINE	FUEL	YEAR	POSITION
9664	AUDI				
	A8	4.2 TDI	DIESEL	09/	PRE DPF
#OEM 4H0.906.088.G					

PRODUCT	MODEL	ENGINE	FUEL	YEAR	POSITION
9665	FORD				
	F250	6.7 V8	DIESEL	11/16	POST DPF/CAT/SCR
	F350	6.7 V8	DIESEL	11/16	POST DPF/CAT/SCR
	F450	6.7 V8	DIESEL	11/16	POST DPF/CAT/SCR
	F550	6.7 V8	DIESEL	11/16	POST DPF/CAT/SCR
#OEM AC3Z-5J213-C					

PRODUCT	MODEL	ENGINE	FUEL	YEAR	POSITION
9666	RENAULT TRUCK				
	C-SERIE	250P, 250PK	DIESEL	13/	PRE DPF
		280P, 280PK	DIESEL	13/	PRE DPF
		320P, 320PK	DIESEL	13/	PRE DPF
		380P, 380PK	DIESEL	13/	PRE DPF
		430P, 430PK	DIESEL	13/	PRE DPF
		440P, 440PK	DIESEL	13/	PRE DPF
		460P, 460PK	DIESEL	13/	PRE DPF
D-SERIE 10	P210, P240	DIESEL	13/	PRE DPF	
D-SERIE 12	P210, P240, P250, P280	DIESEL	13/	PRE DPF	
#OEM 74.21.164.790					

CONTINUING...

EGTS SENSOR

PT200



EXHAUST GAS TEMPERATURE SENSOR ABGASTEMPERATUR

PRODUCT	MODEL	ENGINE	FUEL	YEAR	POSITION	
 <p>9666</p>	RENAULT TRUCK					
	D-SERIE 13	P210, P240, P250, P280	DIESEL	13/	PRE DPF	
	D-SERIE 14	P210, P240, P250, P280	DIESEL	13/	PRE DPF	
	D-SERIE 16	P210, P240, P250, P280	DIESEL	13/	PRE DPF	
	D-SERIE 18	P250, P280, P320, P380	DIESEL	13/	PRE DPF	
	D-SERIE 25	P250, P280, P320	DIESEL	13/	PRE DPF	
	D-SERIE 26	P250, P280, P320	DIESEL	13/	PRE DPF	
	D-SERIE 6.5	P150	DIESEL	16/	PRE DPF	
	D-SERIE 7.5	P180	DIESEL	16/	PRE DPF	
	#OEM 74.21.164.790					
	VOLVO					
	7900	Electric Hybrid	DIESEL	16/	PRE DPF	
	8900	Low Entry	DIESEL	16/	PRE DPF	
	FE II	250-18, 250-26	DIESEL	12/	PRE DPF	
		280-18, 280-26	DIESEL	12/	PRE DPF	
320-18, 320-26		DIESEL	12/	PRE DPF		
FL III	210-10, 210-14, 210-16	DIESEL	13/	PRE DPF		
	240-10, 240-12, 240-14, 240-16	DIESEL	13/	PRE DPF		
	250-12, 250-14, 250-16, 250-18	DIESEL	13/	PRE DPF		
	280-12, 280-14, 280-16, 280-18	DIESEL	13/	PRE DPF		
#OEM 21164790						

PRODUCT	MODEL	ENGINE	FUEL	YEAR	POSITION
 <p>9667</p>	MERCEDES-BENZ				
	A-CLASS	A 180 CDI	DIESEL	04/12	PRE TURBO
		A 200 CDI	DIESEL	04/12	PRE TURBO
	B-CLASS	B 180 CDI	DIESEL	05/11	PRE TURBO
		B 200 CDI	DIESEL	05/11	PRE TURBO
GL-CLASS	GL 350 CDI	DIESEL	13/15	PRE DPF	
#OEM 001.905.24.00					

EGTS SENSOR

PT200



EXHAUST GAS TEMPERATURE SENSOR ABGASTEMPERATUR

PRODUCT	MODEL	ENGINE	FUEL	YEAR	POSITION	
 <p>9668</p>	RENAULT TRUCK					
	MAGNUM	DXi 13.440 DXi 13.460 DXi 13.480 DXi 13.500	DIESEL DIESEL DIESEL DIESEL	09/ 06/ 09/ 09/	- - - -	
	PREMIUM 2	240, 270, 280 310, 320, 340, 370, 380 410, 430, 440, 450, 460	DIESEL DIESEL DIESEL	06/ 06/ 06/	- - -	
	KERAX	370, 410, 450, 460, 500	DIESEL	05/	-	
	MIDLUM	160, 190, 220, 240, 280	DIESEL	06/	-	
	#OEM 74.20.889.280					
	VOLVO					
	FH	400, 420, 440, 460 480, 500, 520, 540	DIESEL DIESEL	05/ 05/	- -	
	FH16	540, 580, 600, 660, 700	DIESEL	09/	-	
	FL II	240, 260, 280, 290	DIESEL	09/	-	
	FM	330, 340, 360, 370 380, 390, 400, 420	DIESEL DIESEL	05/ 05/	- -	
	FMX	330, 370, 380, 400 410, 420, 430, 450 460, 500, 540	DIESEL DIESEL DIESEL	10/ 10/ 10/	- - -	
	#OEM 74.20.889.280					





PRODUCT	MODEL	ENGINE	FUEL	YEAR	POSITION	
 <p>9669</p>	MERCEDES-BENZ					
	A-CLASS	A 160 CDI A 180 CDI A 200 CDI	DIESEL DIESEL DIESEL	04/12 04/12 04/12	PRE CAT PRE CAT PRE CAT	
	B-CLASS	B 180 CDI B 200 CDI	DIESEL DIESEL	05/11 05/11	PRE CAT PRE CAT	
	#OEM 001.905.09.00					

EGTS SENSOR





PT200







EXHAUST GAS TEMPERATURE SENSOR ABGASTEMPERATUR

PRODUCT	MODEL	ENGINE	FUEL	YEAR	POSITION
9671	MERCEDES-BENZ				
	S-CLASS				
	GLK-CLASS	220 CDI 250 CDI	DIESEL DIESEL	08/15 08/15	PRE CAT PRE CAT

#OEM 000.905.26.05 - 000.905.88.00

PRODUCT	MODEL	ENGINE	FUEL	YEAR	POSITION
9672	MERCEDES-BENZ				
	M-CLASS				

#OEM 000.905.03.32

PRODUCT	MODEL	ENGINE	FUEL	YEAR	POSITION
9673	FORD				
	RANGER				

#OEM AB3A-12B591-AA

EGTS SENSOR

PT200







EXHAUST GAS TEMPERATURE SENSOR ABGASTEMPERATUR

PRODUCT	MODEL	ENGINE	FUEL	YEAR	POSITION
9674	VOLKSWAGEN TOUAREG	 2.5 RS TDI	 DIESEL	 03/10	 WITH DPF



#OEM 070.906.088.E

PRODUCT	MODEL	ENGINE	FUEL	YEAR	POSITION
9675	FORD RANGER	 2.2 TDCi	 DIESEL	 16/	 POST DPF



#OEM EB3G-12B591-FA - EB3G-12B591-FB

EGTS SENSOR

PT200



EXHAUST GAS TEMPERATURE SENSOR ABGASTEMPERATUR

PRODUCT	MODEL	ENGINE	FUEL	YEAR	POSITION
 <p>9676</p>	FIAT				
	FIORINO	1.3 D Multijet	DIESEL	07/	POST DPF
	QUBO	1.3 D Multijet	DIESEL	08/	POST DPF
	#OEM 51825683				
	IVECO				
	STRALIS				
		AD-AT 190S30-46	DIESEL	03/	-
		AD-AT 260S31-56	DIESEL	03/	-
		AD-AT-AS 320S45	DIESEL	07/	-
		AD-AT-AS 440S42	DIESEL	06/	-
	TRAKKER				
		AD-AT 190T31-45	DIESEL	04/	-
		AD-AT 260T33-50	DIESEL	06/	-
		AD-AT 340T36-45	DIESEL	06/	-
		AD-AT 380T36-50	DIESEL	07/	-
	AD-AT 400T36-50	DIESEL	06/	-	
	AD-AT 410T36-50	DIESEL	07/	-	
	AD-AT 440T41-50	DIESEL	07/	-	
	AD-AT 720T41-51	DIESEL	06/	-	
EUROCARGO I-III					
	100, 110, 120, 140	DIESEL	05/15	-	
	150, 160, 180, 190	DIESEL	05/15	-	
EUROCARGO IV					
	180	DIESEL	15/	-	
EUROFIVE					
	100, 120, 140, 150, 160	DIESEL	06/	-	
STRATOR					
	ASN440	DIESEL	10/	-	
#OEM 504102603 - 5801291815 - 5801455940					

PRODUCT	MODEL	ENGINE	FUEL	YEAR	POSITION
 <p>9677</p>	SMART				
	FORTWO	0.8 CDI	DIESEL	09/	POST CAT
#OEM 000.905.17.32 - 000.905.08.32					

EGTS SENSOR

PT200



EXHAUST GAS TEMPERATURE SENSOR ABGASTEMPERATUR

PRODUCT	MODEL	ENGINE	FUEL	YEAR	POSITION
9678	AUDI				
	A6				
	Q5	3.0 TDI Quattro	DIESEL	12/	PRE DPF
<p>#OEM 460.906.088.H</p>					

PRODUCT	MODEL	ENGINE	FUEL	YEAR	POSITION
9679	AUDI				
	A6				
<p>#OEM 059.906.088.BM</p>					





PRODUCT	MODEL	ENGINE	FUEL	YEAR	POSITION
9680	PORSCHE				
	CAYENNE				
	VOLKSWAGEN				
	TOUAREG				
<p>#OEM 059.906.088.BN</p>					





EGTS SENSOR





PT200



EXHAUST GAS TEMPERATURE SENSOR ABGASTEMPERATUR

PRODUCT	MODEL	ENGINE	FUEL	YEAR	POSITION
9681 	VOLKSWAGEN				
	CRAFTER 30-35	2.5 TDI	DIESEL	06/11	PRE DPF
	CRAFTER 30-50	2.5 TDI	DIESEL	06/13	PRE DPF
#OEM 076.906.088.A					

PRODUCT	MODEL	ENGINE	FUEL	YEAR	POSITION
9682 	AUDI				
	A6	2.7 TDI 2.7 TDI Quattro 3.0 TDI Quattro	DIESEL DIESEL DIESEL	04/11 08/11 04/11	PRE DPF PRE DPF PRE DPF
	#OEM 059.906.088.BH				

PRODUCT	MODEL	ENGINE	FUEL	YEAR	POSITION
9683 	NAVISTAR				
	1300	MaxxForce	DIESEL	08/12	PRE DPF
	4100	MaxxForce	DIESEL	08/16	PRE DPF
	4300	MaxxForce	DIESEL	08/16	PRE DPF
	4400	MaxxForce	DIESEL	08/16	PRE DPF
	7300	MaxxForce	DIESEL	08/15	PRE DPF
	7400	MaxxForce	DIESEL	08/16	PRE DPF
	7500	MaxxForce	DIESEL	08/10	PRE DPF
#OEM 2593756C91					

EGTS SENSOR

PT200



EXHAUST GAS TEMPERATURE SENSOR ABGASTEMPERATUR

PRODUCT	MODEL	ENGINE	FUEL	YEAR	POSITION
 <p>9684</p>	NAVISTAR				
	4300	MaxxForce	DIESEL	08/11	PRE DPF
	4400	MaxxForce	DIESEL	08/10	PRE DPF
	7300	MaxxForce	DIESEL	08/15	PRE DPF
	7400	MaxxForce	DIESEL	08/15	PRE DPF

#OEM 2593755C91

PRODUCT	MODEL	ENGINE	FUEL	YEAR	POSITION
 <p>9685</p>	NAVISTAR				
	1300	MaxxForce	DIESEL	08/12	PRE DPF
	4100	MaxxForce	DIESEL	08/11	PRE DPF
	4300	MaxxForce	DIESEL	08/11	PRE DPF
	4400	MaxxForce	DIESEL	08/10	PRE DPF
	7300	MaxxForce	DIESEL	08/15	PRE DPF
	7400	MaxxForce	DIESEL	08/15	PRE DPF

#OEM 2593754C91

PRODUCT	MODEL	ENGINE	FUEL	YEAR	POSITION
 <p>9686</p>	FORD				
	TRANSIT	2.2 TDCI	DIESEL	11/14	PRE DPF
	TRANSIT V363	2.2 TDCI	DIESEL	13/	PRE DPF





#OEM CC1A-12B591-BB

EGTS SENSOR

PT200







EXHAUST GAS TEMPERATURE SENSOR ABGASTEMPERATUR

PRODUCT	MODEL	ENGINE	FUEL	YEAR	POSITION
9687	MERCEDES-BENZ	 C220 C250 BlueTEC	 DIESEL DIESEL	 15/18 14/18	 PRE DPF PRE DPF
	C-CLASS				
	GLC-CLASS	C220 C250	DIESEL DIESEL	15/19 16/19	PRE DPF PRE DPF

#OEM A.000.905.08.05



PRODUCT	MODEL	ENGINE	FUEL	YEAR	POSITION
9688	OPEL	 2.0 CDTI Bi-Turbo	 DIESEL	 08/17	 PRE CAT
	INSIGNIA A				
	#OEM 855287 55566817 5855388				
SAAB	9-5	2.0 TTD	DIESEL	10/12	PRE CAT
#OEM 55575039					
VAUXHALL	INSIGNIA MkI	2.0 CDTI Bi-Turbo	DIESEL	08/17	PRE CAT
#OEM 55575039					

















EGTS SENSOR

PT200



EXHAUST GAS TEMPERATURE SENSOR ABGASTEMPERATUR

PRODUCT	MODEL	ENGINE	FUEL	YEAR	POSITION
9690 	GM-CHEVROLET	 1.7 TD	 DIESEL	 12/	 POST DPF
	TRAXX				
	#OEM 55564270 55578722				
	OPEL	 1.7 CDTI	 DIESEL	 11/15	 POST DPF
	ASTRA J				
	CORSA D				
	INSIGNIA A				
	MOKKA				
	#OEM 855460 1247292				
	VAUXHALL	1.7 CDTI	DIESEL	12/	POST CAT
MOKKA X					
#OEM 55588650 - 1247292					





PRODUCT	MODEL	ENGINE	FUEL	YEAR	POSITION
9691 	GM-CHEVROLET	 1.7 D	 DIESEL	 12/	 POST CAT
	CRUZE				
	#OEM 55578799				
	OPEL	1.7 CDTI	DIESEL	09/15	POST CAT
ASTRA J					
#OEM 855460 - 1247292					





EGTS SENSOR





PT200



EXHAUST GAS TEMPERATURE SENSOR ABGASTEMPERATUR

PRODUCT	MODEL	ENGINE	FUEL	YEAR	POSITION
9692	AUDI				
	A4	2.0 16V TDI	DIESEL	04/08	PRE TURBO
	A6	2.0 TDI	DIESEL	04/11	PRE TURBO
#OEM 03G.906.088R					

PRODUCT	MODEL	ENGINE	FUEL	YEAR	POSITION
9693	OPEL				
	CORSA D	1.7 CDTI	DIESEL	09/14	PRE CAT
	MERIVA B	1.7 CDTI	DIESEL	10/17	PRE CAT
#OEM 855286					

PRODUCT	MODEL	ENGINE	FUEL	YEAR	POSITION
9694	IVECO				
	DAILY IV	35 S11/14	DIESEL	06/11	PRE DPF
		29 L10/12/14	DIESEL	06/11	PRE DPF
		35 C10/11/12/14/18	DIESEL	06/11	PRE DPF
		40 C15/18	DIESEL	06/11	PRE DPF
		50 C15/18	DIESEL	06/11	PRE DPF
	65 C15/18	DIESEL	06/11	PRE DPF	
#OEM 69502363					

EGTS SENSOR

PT200



EXHAUST GAS TEMPERATURE SENSOR ABGASTEMPERATUR

PRODUCT	MODEL	ENGINE	FUEL	YEAR	POSITION
9695 	MERCEDES-BENZ				
	ATEGO	1014, 1928	DIESEL	98/04	DOWNSTREAM CAT
	ATEGO 2	1015, 2529 712, 926	DIESEL DIESEL	04/ 04/	DOWNSTREAM CAT DOWNSTREAM CAT
	AXOR 2	1823, 2633	DIESEL	04/	DOWNSTREAM CAT
	ECONIC	1823, 3233	DIESEL	01/	DOWNSTREAM CAT
	OH SERIES	1518, 1618	DIESEL	95/	DOWNSTREAM CAT
	TOURO	500 M/U	DIESEL	01/	DOWNSTREAM CAT
	UNIMOG	U3000, 4000, 5000	DIESEL	02/	DOWNSTREAM CAT
	ZETROS	1833, 2733	DIESEL	08/	DOWNSTREAM CAT
	#OEM 006.153.05.28				





PRODUCT	MODEL	ENGINE	FUEL	YEAR	POSITION
9696 	MERCEDES-BENZ				
	ACTROS	MP2-MP3 183, 5048	DIESEL	03/	UPSTREAM CAT
	ATEGO	1017A, 1828L	DIESEL	98/04	UPSTREAM CAT
	ATEGO 2	1018A, 1728S	DIESEL	04/	UPSTREAM CAT
	AXOR	1823, 3228 C	DIESEL	02/04	UPSTREAM CAT
	AXOR 2	1823AK, 4144	DIESEL	04/	UPSTREAM CAT
	ECONIC	1823L, 3233LL	DIESEL	01/	UPSTREAM CAT
	TOURO	0 500	DIESEL	01/	UPSTREAM CAT
	UNIMOG	U20, 500	DIESEL	00/	UPSTREAM CAT
	#OEM 006.153.06.28				

EGTS SENSOR





PT200







EXHAUST GAS TEMPERATURE SENSOR ABGASTEMPERATUR

PRODUCT	MODEL	ENGINE	FUEL	YEAR	POSITION
9697 	MERCEDES-BENZ				
	ACTROS	MP2-MP3 1831AK, 5048AK	DIESEL	03/	DOWNSTREAM CAT
	ATEGO	1823AK, 2628K	DIESEL	98/04	DOWNSTREAM CAT
	AXOR	1823, 3228 C	DIESEL	02/04	DOWNSTREAM CAT
	AXOR 2	1823AK, 4144	DIESEL	04/	DOWNSTREAM CAT

#OEM 006.153.07.28

PRODUCT	MODEL	ENGINE	FUEL	YEAR	POSITION
9698 	VOLVO				
	8900	8900 LOW ENTRY	DIESEL	16/	POST DPF
	9500	9500	DIESEL	16/	POST DPF
	9700	9700	DIESEL	09/	POST DPF
	9900	9900	DIESEL	07/	POST DPF
	B5	B5	DIESEL	08/	POST DPF

#OEM 21164792

PRODUCT	MODEL	ENGINE	FUEL	YEAR	POSITION
9699 	RENAULT				
	KERAX	370.18/26/32 410.26/32 450.18/26/32 500.32	DIESEL DIESEL DIESEL DIESEL	05/ 05/ 05/ 05/	- - - -
	MAGNUM	13 440.19 13 460.18/24/25/26 13 480.19/26 13 500.25/26 13 520.18/19/24/25/26	DIESEL DIESEL DIESEL DIESEL DIESEL	06/ 06/ 06/ 06/ 06/	- - - - -
	PREMIUM 2	370.26, 460.26	DIESEL	06/	-

#OEM 74.21.412.472





CONTINUING...

EGTS SENSOR





PT200



EXHAUST GAS TEMPERATURE SENSOR ABGASTEMPERATUR

PRODUCT	MODEL	ENGINE	FUEL	YEAR	POSITION
9699 	VOLVO				
	FH 16	16/540 16/600	DIESEL DIESEL	09/ 09/	- -
	FH 400	400, 440, 460, 480	DIESEL	05/	-
	FH 500	500, 520, 540	DIESEL	05/	-
	FM	360, 380, 400, 420, 440, 460, 500	DIESEL	05/	-
	FMX	330, 380, 410, 420, 450, 460, 500	DIESEL	10/	-

#OEM 21412472 - 21225020

PRODUCT	MODEL	ENGINE	FUEL	YEAR	POSITION
96000 	VOLVO				
	9700	9700	DIESEL	16/	-
	9900	9900	DIESEL	16/	-
	B11	11R	DIESEL	11/	-

#OEM 21126692

PRODUCT	MODEL	ENGINE	FUEL	YEAR	POSITION
96001 	OPEL				
	INSIGNIA	2.0 CDTI	DIESEL	08/17	PRE DPF

#OEM 1247634 - 55591173 - 55496933

EGTS SENSOR

PT200



EXHAUST GAS TEMPERATURE SENSOR ABGASTEMPERATUR

PRODUCT	MODEL	ENGINE	FUEL	YEAR	POSITION
96002 	FIAT				
	500	1.3 D Multijet	DIESEL	09/	PRE CAT
	DOBLO	1.3 D Multijet	DIESEL	10/	PRE CAT
	FIORINO	1.3 D Multijet	DIESEL	09/	PRE CAT
	IDEA	1.3 D Multijet	DIESEL	08/12	PRE CAT
	LINEA	1.3 D Multijet	DIESEL	09/	PRE CAT
	PUNTO	1.3 D Multijet	DIESEL	12/	PRE CAT
	QUBO	1.3 D Multijet	DIESEL	10/	PRE CAT
	STRADA	1.3 D Multijet	DIESEL	10/	PRE CAT
	#OEM 21412472 21225020				
	LANCIA				
	MUSA	1.3 D Multijet	DIESEL	09/12	PRE CAT
	YPSILON	1.3 D Multijet	DIESEL	11/	PRE CAT
	#OEM 55243388				
	OPEL				
COMBO	1.3 CDTI	DIESEL	12/	PRE DPF	
#OEM 1249073 - 95519373					

PRODUCT	MODEL	ENGINE	FUEL	YEAR	POSITION
96003 	DAF				
	XF95	FA410 - EURO 5	DIESEL	01/05	POST CAT
	XF105	FA410 - EURO 5	DIESEL	05/13	POST CAT
	CF75 IV	FA410 - EURO 5	DIESEL	05/13	POST CAT
	CF85 IV	FA410 - EURO 5	DIESEL	05/13	POST CAT
	MX300/340/375	FA410 - EURO 5	DIESEL	05/13	POST CAT
	#OEM 1689812 - 1810691 - 1612300 - 1612372				

EGTS SENSOR

PT200



EXHAUST GAS TEMPERATURE SENSOR ABGASTEMPERATUR

PRODUCT	MODEL	ENGINE	FUEL	YEAR	POSITION
96004 	DAF				
	XF95	FA410 - EURO 5	DIESEL	05/	PRE CAT
	XF105	FA410 - EURO 5	DIESEL	05/13	PRE CAT
	CF75 IV	FA410 - EURO 5	DIESEL	05/13	PRE CAT
	CF85 IV	FA410 - EURO 5	DIESEL	05/13	PRE CAT
#OEM 1689811 - 1810690 - 3468052 - 1677124					

PRODUCT	MODEL	ENGINE	FUEL	YEAR	POSITION
96005 	GM-CHEVROLET				
	CAPTIVA	2.0 D	DIESEL	06/	PRE CAT
	#OEM 25183660				
OPEL					
ANTARA	2.0 CDTI	DIESEL	06/11	PRE CAT	
#OEM 96994636					

PRODUCT	MODEL	ENGINE	FUEL	YEAR	POSITION
96006 	OPEL				
	SIGNUM	1.9 CDTI	DIESEL	04/08	PRE DPF
	VECTRA C	1.9 CDTI	DIESEL	04/09	PRE DPF
#OEM 855505 - 55190617					





EGTS SENSOR





PT200



EXHAUST GAS TEMPERATURE SENSOR ABGASTEMPERATUR

PRODUCT	MODEL	ENGINE	FUEL	YEAR	POSITION
96007 	IVECO				
	EUROCARGO I-III	120 E20	DIESEL	06/15	PRE CAT
	EUROCARGO V	160 E21	DIESEL	15/	PRE CAT
#OEM 5801291814					

PRODUCT	MODEL	ENGINE	FUEL	YEAR	POSITION
96008 	FIAT				
	500	1.3 D Multijet	DIESEL	07/	PRE DPF
	PANDA	1.3 D Multijet	DIESEL	06/13	PRE DPF
#OEM 51779770					

PRODUCT	MODEL	ENGINE	FUEL	YEAR	POSITION
96009 	AUDI				
	A4	2.0 TDI	DIESEL	08/15	PRE TURBO
	A5	2.0 TDI	DIESEL	08/17	PRE TURBO
	Q5	2.0 TDI	DIESEL	08/17	PRE TURBO
#OEM 03L.906.088.AG					

EGTS SENSOR

PT200



EXHAUST GAS TEMPERATURE SENSOR ABGASTEMPERATUR

PRODUCT	MODEL	ENGINE	FUEL	YEAR	POSITION
96010					
	AUDI				
	A4	2.0 TDI	DIESEL	07/15	POST DPF
	A5	2.0 TDI	DIESEL	09/17	POST DPF
	Q5	2.0 TDI	DIESEL	08/17	POST DPF
#OEM 03L.906.088.F					



PRODUCT	MODEL	ENGINE	FUEL	YEAR	POSITION
96011					
	AUDI				
	A4	2.0 TDI	DIESEL	08/15	PRE TURBO
	A5	2.0 TDI	DIESEL	08/17	PRE TURBO
	Q5	2.0 TDI	DIESEL	08/17	PRE TURBO
#OEM 03L.906.088.BT					



PRODUCT	MODEL	ENGINE	FUEL	YEAR	POSITION
96013					
	AUDI				
	A8	4.0 - 4.2 TDI 4.2 FSI	DIESEL DIESEL	08/15 09/12	PRE TURBO PRE TURBO
	Q7	4.2 TDI	DIESEL	07/15	PRE TURBO
#OEM 057.906.088.A					
VOLKSWAGEN					
	TOUAREG	4.2 V8 TDI	DIESEL	10/18	PRE TURBO
#OEM 057.906.088.A					







EGTS SENSOR





PT200



EXHAUST GAS TEMPERATURE SENSOR ABGASTEMPERATUR

PRODUCT	MODEL	ENGINE	FUEL	YEAR	POSITION
96014 	MERCEDES-BENZ				
	C-CLASS	C 320 CDI CLS 320 CDI CLS 350 CDI	DIESEL DIESEL DIESEL	07/14 05/10 09/10	PRE DPF PRE DPF PRE DPF
	R-CLASS	R 280 CDI R 300 CDI R 320 CDI R 350 CDI	DIESEL DIESEL DIESEL DIESEL	06/12 09/12 06/10 09/12	PRE DPF PRE DPF PRE DPF PRE DPF

#OEM A.007.153.79.28

PRODUCT	MODEL	ENGINE	FUEL	YEAR	POSITION
96015 	SEAT				
	ALHAMBRA	2.0 TDI	DIESEL	05/10	PRE TURBO
	VOLKSWAGEN				
	SHARANN	2.0 TDI	DIESEL	05/10	PRE TURBO





#OEM 03G.906.088.L





EGTS SENSOR

PT200



EXHAUST GAS TEMPERATURE SENSOR ABGASTEMPERATUR

PRODUCT	MODEL	ENGINE	FUEL	YEAR	POSITION
 96016	GM-CHEVROLET				
	CRUZE	1.7 D	DIESEL	12/	POST CAT
	#OEM 55578800				
	OPEL				
	ASTRA J	1.7 CDTI	DIESEL	09/15	POST CAT
	#OEM 55578800				
VAUXHALL					
ASTRA Mk VI	1.7 CDTI	DIESEL	09/15	POST CAT	
#OEM 55578800					

PRODUCT	MODEL	ENGINE	FUEL	YEAR	POSITION
 96017	ALFA ROMEO				
	147	1.9 JTD	DIESEL	01/10	PRE CAT
	GT	1.9 JTD	DIESEL	03/10	PRE CAT
	#OEM 55204763				

EGTS SENSOR

PT200



EXHAUST GAS TEMPERATURE SENSOR ABGASTEMPERATUR

PRODUCT	MODEL	ENGINE	FUEL	YEAR	POSITION
96018	VOLVO				
	S60 I	2.4 D	DIESEL	05/10	PRE DPF
	V70 II	2.4 D	DIESEL	05/08	PRE DPF
	XC70	2.4 D5	DIESEL	05/07	PRE DPF
	XC90 I	2.4 D5	DIESEL	07/14	PRE DPF



#OEM 31293172 - 30751456 - 31370463 - 31431045 - 50422509

PRODUCT	MODEL	ENGINE	FUEL	YEAR	POSITION
96019	AUDI				
	A4	3.0 TDI	DIESEL	15/18	PRE TURBO
	A5	3.0 TDI	DIESEL	16/18	PRE TURBO
	A6	3.0 TDI	DIESEL	14/18	PRE TURBO
	Q7	3.0 TDI	DIESEL	15/19	PRE TURBO
	VOLKSWAGEN				
	AMAROK	3.0 TDI	DIESEL	16/	PRE TURBO



#OEM 059.906.088.CP





#OEM 059.906.088.CP

EGTS SENSOR





PT200



EXHAUST GAS TEMPERATURE SENSOR ABGASTEMPERATUR

PRODUCT	MODEL	ENGINE	FUEL	YEAR	POSITION
96020 	VOLVO				
	C30	2.0 D3 - D4	DIESEL	05/10	PRE DPF
	C70 II	2.0 D3 - D4	DIESEL	10/13	PRE CAT
	S40 II	2.0 D3 - D4	DIESEL	10/12	PRE DPF
	S60 II	2.0 D5	DIESEL	14/15	PRE DPF
	S80 II	2.4 D 2.0 D3 - D4	DIESEL DIESEL	10/11 10/16	PRE DPF PRE DPF
	V40	2.0 D3 - D4	DIESEL	12/15	PRE DPF
	V50	2.0 D3 - D4	DIESEL	10/12	PRE DPF
	V60 I	2.4 D5	DIESEL	10/15	PRE DPF
	V70 III	2.0 D3 - D4	DIESEL	09/15	PRE DPF
	XC60 I	2.0 D3 - D4 - D5	DIESEL	10/17	PRE DPF
	XC70 II	2.4 D	DIESEL	09/15	PRE DPF

#OEM 31370692

PRODUCT	MODEL	ENGINE	FUEL	YEAR	POSITION
96021 	VOLVO				
	S60 II	2.4 D5	DIESEL	10/15	PRE CAT
	S80 II	2.4 D5	DIESEL	10/15	PRE DPF
	V60 I	2.4 D5	DIESEL	11/15	PRE DPF
	V70 III	2.4 D5	DIESEL	09/16	PRE DPF
	XC60 I	2.4 D - D3 - D5	DIESEL	09/17	PRE DPF
	XC70 II	2.4 D4 - D5	DIESEL	07/16	PRE DPF





#OEM 31319840 - 31319265 - 31370466 31431048





EGTS SENSOR





PT200



EXHAUST GAS TEMPERATURE SENSOR ABGASTEMPERATUR

PRODUCT	MODEL	ENGINE	FUEL	YEAR	POSITION
96022	OPEL				
	ANTARA				
					
#OEM 4803548 - 4818659 - 25183663 - 96474598					

PRODUCT	MODEL	ENGINE	FUEL	YEAR	POSITION				
96023	SCANIA								
	TRUCKS					SERIES P/G/R/T	DIESEL	03/20	PRE CAT
	BUS					SERIES F/K/N	DIESEL	04/20	PRE CAT
									
#OEM 1882567 - 2265872 - 2253825									

PRODUCT	MODEL	ENGINE	FUEL	YEAR	POSITION				
96024	VOLVO								
	C30					2.0 D3 - D4	DIESEL	10/12	POST DPF
	C70 II					2.0 D3 - D4	DIESEL	10/13	POST DPF
	S40 II					2.0 D3 - D4 - D5	DIESEL	10/12	POST DPF
	S60 II					2.0 D3 - D4 - D5	DIESEL	10/15	POST DPF
	S80 II					2.0 D3 - D4 - D5	DIESEL	10/16	POST DPF
									
#OEM 31370468 - 31303026 - 31319842 - 31431049									





CONTINUING...

EGTS SENSOR





PT200



EXHAUST GAS TEMPERATURE SENSOR ABGASTEMPERATUR

PRODUCT	MODEL	ENGINE	FUEL	YEAR	POSITION
96024 	VOLVO				
	V40	2.0 D3 - D4 - D5	DIESEL	12/	POST DPF
	V50	2.0 D3 - D4 - D5	DIESEL	10/12	POST DPF
	V60 I	2.0 D3 - D4 - D5	DIESEL	12/15	POST DPF
	V70 III	2.0 D3 - D4 - D5	DIESEL	08/15	POST DPF
	XC60 I	2.0 D5	DIESEL	09/17	POST DPF
	XC70 II	2.0 D5	DIESEL	10/15	POST DPF

#OEM 31370468 - 31303026 - 31319842 - 31431049

PRODUCT	MODEL	ENGINE	FUEL	YEAR	POSITION
96025 	NAVISTAR				
	4100, 4300, 4400	6.4	DIESEL	08/11	PRE TURBO
	1300 FBC	7.6	DIESEL	08/12	PRE TURBO
	7300, 7400, 7500	7.6	DIESEL	08/12	PRE TURBO
	CE	6.4, 7.6	DIESEL	08/10	PRE TURBO
	FE, HC, RE	7.6	DIESEL	08/10	PRE TURBO

#OEM 2593753C92

PRODUCT	MODEL	ENGINE	FUEL	YEAR	POSITION
96026 	VOLKSWAGEN				
	TIGUAN	2.0 TDI	DIESEL	07/18	PRE DPF





#OEM 03L.906.088.C

EGTS SENSOR

PT200







EXHAUST GAS TEMPERATURE SENSOR ABGASTEMPERATUR

PRODUCT	MODEL	ENGINE	FUEL	YEAR	POSITION
96027	FIAT				
	MULTIPLICA				

#OEM 55199053



PRODUCT	MODEL	ENGINE	FUEL	YEAR	POSITION					
96028	ALFA ROMEO									
	159					2.0 JTDM	DIESEL	09/11	POST CAT	
	BRERA					2.0 JTDM	DIESEL	09/10	POST CAT	
						2.4 JTDM	DIESEL	06/11	POST DPF	
	SPIDER					2.0 JTDM	DIESEL	09/10	POST CAT	
						2.4 JTDM	DIESEL	06/11	POST DPF	
	#OEM 51830621 55220508 51867072 55229330									
	FIAT									
	LINEA					1.6 D Multijet	DIESEL	09/	POST CAT	
	SEDICI					1.9 d Multijet	DIESEL	06/11	POST CAT	
#OEM 55199543										
SUZUKI										
SX4	1.9 DDIS	DIESEL	06/	POST CAT						

#OEM 18213-79J60







EGTS SENSOR

PT200



EXHAUST GAS TEMPERATURE SENSOR ABGASTEMPERATUR





PRODUCT	MODEL	ENGINE	FUEL	YEAR	POSITION
96029	FIAT	 1.9 JTD Multijet	 DIESEL	 05/	 PRE CAT
	DOBLO				



FIAT

DOBLO

#OEM 55203808

PRODUCT	MODEL	ENGINE	FUEL	YEAR	POSITION				
96030	ALFA ROMEO	 1.9 JTDM 16V 1.9 JTDM 8V 1.9 JTS 2.4 JTDM	 DIESEL	 05/11	 PRE CAT				
						BRERA	DIESEL	05/11	PRE CAT
							DIESEL	05/11	PRE CAT
							DIESEL	05/11	PRE CAT
		2.4 JTDM 20V	DIESEL	06/11	PRE CAT				



ALFA ROMEO

159

BRERA

#OEM 51802893
55199541
55207108

LANCIA

DELTA III

#OEM 55207108

EGTS SENSOR

PT200



EXHAUST GAS TEMPERATURE SENSOR ABGASTEMPERATUR

PRODUCT	MODEL	ENGINE	FUEL	YEAR	POSITION
96031 	FIAT				
	500	1.3 D Multijet	DIESEL	07/	POST DPF
	500 C	1.3 D Multijet	DIESEL	09/	POST DPF
	500 L	1.3 D Multijet	DIESEL	12/	POST DPF
	PANDA	1.3 D Multijet	DIESEL	12/	POST DPF
	TIPO	1.3 D Multijet	DIESEL	15/	POST CAT
	#OEM 51861682 55228650				
	LANCIA				
	YPSILON	1.3 D Multijet	DIESEL	06/11	PRE DPF
	#OEM 55228650				

PRODUCT	MODEL	ENGINE	FUEL	YEAR	POSITION
96032 	FIAT				
	MULTIPLA	1.9 JTD	DIESEL	02/10	POST DPF
	STILO	1.9 JTD	DIESEL	05/06	POST DPF
	#OEM 55197011				

EGTS SENSOR

PT200



EXHAUST GAS TEMPERATURE SENSOR ABGASTEMPERATUR

PRODUCT	MODEL	ENGINE	FUEL	YEAR	POSITION
96033 	OPEL				
	SIGNUM	1.9 CDTI	DIESEL	05/08	POST CAT
	VECTRA C	1.9 CDTI	DIESEL	04/09	POST CAT
	#OEM 55557466 855415				
	VAUXHALL				
	SIGNUM	1.9 CDTI	DIESEL	05/08	POST DPF
VECTRA Mk II	1.9 CDTI	DIESEL	04/08	POST DPF	
#OEM 55557466					





PRODUCT	MODEL	ENGINE	FUEL	YEAR	POSITION
96034 	GM-CHEVROLET				
	CAPTIVA	2.0 D	DIESEL	07/	POST CAT
	#OEM 25183664				
	OPEL				
ANTARA	2.0 CDTI	DIESEL	07/11	POST CAT	
#OEM 96994638					





EGTS SENSOR

PT200



EXHAUST GAS TEMPERATURE SENSOR ABGASTEMPERATUR

PRODUCT	MODEL	ENGINE	FUEL	YEAR	POSITION
96035	MERCEDES-BENZ				
	C-CLASS	CLK 320 CDI	DIESEL	05/09	PRE DPF
	SLK	350	DIESEL	11/	PRE CAT
#OEM 007.153.78.28 - 000.905.78.01					

PRODUCT	MODEL	ENGINE	FUEL	YEAR	POSITION	
96036	ALFA ROMEO					
	GIULIA	2.2 D	DIESEL	15/	PRE DPF/CAT	
	GIULIETTA	1.6 JTDM 2.0 JTDM	DIESEL DIESEL	15/ 10/	PRE DPF/CAT PRE DPF/CAT	
	STELVIO	2.2 D	DIESEL	16/	-	
	#OEM 55271704 55279495					
	FIAT					
	500X	1.6 D Multijet 2.0 D Multijet	DIESEL DIESEL	14/ 18/	PRE DPF/CAT PRE DPF/CAT	
	DOBLO	1.6 D Multijet	DIESEL	15/	PRE DPF/CAT	
	TIPO	1.6 D Multijet	DIESEL	16/	PRE DPF/CAT	
	#OEM 55271703 55271704					
	JEEP					
	RENEGADE	1.6 CRD 2.0 CRD	DIESEL DIESEL	16/ 14/	PRE DPF/CAT PRE DPF/CAT	
#OEM 55254789 - 55271493						





CONTINUING...

EGTS SENSOR

PT200







EXHAUST GAS TEMPERATURE SENSOR ABGASTEMPERATUR

PRODUCT	MODEL	ENGINE	FUEL	YEAR	POSITION
96036	OPEL				
	COMBO				







#OEM 55250523 55270986

PRODUCT	MODEL	ENGINE	FUEL	YEAR	POSITION				
96037	OPEL								
	ASTRA H					1.7 CDTI	DIESEL	07/14	PRE DPF
	ZAFIRA B					1.7 CDTI	DIESEL	08/15	PRE DPF



#OEM 55566086

PRODUCT	MODEL	ENGINE	FUEL	YEAR	POSITION				
96038	GM-CHEVROLET								
	CAPTIVA					2.0 D 2.2 D	DIESEL DIESEL	11/ 11/	PRE DPF PRE DPF
	CRUZE					2.0 CDI	DIESEL	09/	PRE DPF
	ORLANDO					2.0 D	DIESEL	11/	PRE DPF



V#OEM 96868946 25186658

CONTINUING...

EGTS SENSOR

PT200



EXHAUST GAS TEMPERATURE SENSOR ABGASTEMPERATUR

PRODUCT	MODEL	ENGINE	FUEL	YEAR	POSITION
	96038				
	OPEL				
	ANTARA	2.2 CDTI	DIESEL	10/15	PRE DPF
	#OEM 96868946				
	VAUXHALL				
	ANTARA	2.2 CDTI	DIESEL	10/	PRE DPF
	#OEM 96868946				

PRODUCT	MODEL	ENGINE	FUEL	YEAR	POSITION
	96039				
	GM-CHEVROLET				
	CAPTIVA	2.0 D 2.2 D	DIESEL DIESEL	11/ 11/	PRE TURBO PRE TURBO
	CRUZE	2.0 CDI	DIESEL	09/	PRE TURBO
	ORLANDO	2.0 D	DIESEL	11/	PRE TURBO
	#OEM 96868940				

PRODUCT	MODEL	ENGINE	FUEL	YEAR	POSITION
	96040				
	OPEL				
	MERIVA B	1.7 CDI	DIESEL	10/17	POST CAT
	#OEM 55571194				

EGTS SENSOR

PT200



EXHAUST GAS TEMPERATURE SENSOR ABGASTEMPERATUR

PRODUCT	MODEL	ENGINE	FUEL	YEAR	POSITION
96041					
	OPEL				
	ASTRA H	1.7 CDTI	DIESEL	07/14	POST DPF/CAT
	ZAFIRA B	1.7 CDTI	DIESEL	08/15	POST DPF
	#OEM 55566621				

PRODUCT	MODEL	ENGINE	FUEL	YEAR	POSITION
96042					
	OPEL				
	ASTRA J	1.7 CDI	DIESEL	09/15	PRE CAT
	#OEM 55571362				





PRODUCT	MODEL	ENGINE	FUEL	YEAR	POSITION
96043					
	GM-CHEVROLET				
	CRUZE	1.7 D	DIESEL	12/	PRE CAT
	#OEM 55574183				
	OPEL				
	ASTRA J	1.7 CDTI	DIESEL	09/15	PRE CAT
	MERIVA B	1.7 CDTI	DIESEL	10/15	PRE CAT
	MOKKA	1.7 CDTI	DIESEL	12/	PRE CAT
	#OEM 55574938				

EGTS SENSOR

PT200







EXHAUST GAS TEMPERATURE SENSOR ABGASTEMPERATUR

PRODUCT	MODEL	ENGINE	FUEL	YEAR	POSITION
96044	OPEL				
	MERIVA B				







#OEM 55565652 - 855255

PRODUCT	MODEL	ENGINE	FUEL	YEAR	POSITION				
96045	AUDI								
	A4					2.0 TDI	DIESEL	16/19	POST DPF
	A5					2.0 TDI	DIESEL	17/	POST DPF
	Q5					2.0 TDI	DIESEL	17/	POST DPF



#OEM 8W0 906 088 F

PRODUCT	MODEL	ENGINE	FUEL	YEAR	POSITION				
96046	AUDI								
	A4					2.0 TDI	DIESEL	16/19	PRE CAT
	A5					2.0 TDI	DIESEL	17/	PRE CAT
	Q5					2.0 TDI	DIESEL	17/	PRE CAT







#OEM 8W0 906 088 E - 8W0 906 088 Q

EGTS SENSOR

PT200







EXHAUST GAS TEMPERATURE SENSOR ABGASTEMPERATUR

PRODUCT	MODEL	ENGINE	FUEL	YEAR	POSITION
96047	GM-CHEVROLET				
	S10	2.8 16V - TURBO	DIESEL	15/	PRE CAT
	TRAILBLAZER	2.8 16V - TURBO	DIESEL	16/	PRE CAT





#OEM 55499997



PRODUCT	MODEL	ENGINE	FUEL	YEAR	POSITION
96048	GM-CHEVROLET				
	ASTRA H	1.7 CDTI	DIESEL	07/14	PRE DPF
	ZAFIRA	1.7 CDTI	DIESEL	08/15	PRE DPF

#OEM 55562433



PRODUCT	MODEL	ENGINE	FUEL	YEAR	POSITION
96049	AUDI				
	A4	2.0 TDI	DIESEL	09/16	ON DPF
	A5	2.0 TDI	DIESEL	09/17	ON DPF
	A6	2.0 TDI	DIESEL	12/18	ON DPF
	Q5	2.0 TDI	DIESEL	09/17	ON DPF

#OEM 460.906.088.AA - 460.906.088.L - 460.906.088.AN







EGTS SENSOR





PT200







EXHAUST GAS TEMPERATURE SENSOR ABGASTEMPERATUR

PRODUCT	MODEL	ENGINE	FUEL	YEAR	POSITION
96050 	FORD				
	TOURNEO	2.2 TDGi	DIESEL	12/15	ON DPF
	TRANSIT	2.2 TDGi	DIESEL	12/15	ON DPF

#OEM BK2A-12B591-AB - 1792122

PRODUCT	MODEL	ENGINE	FUEL	YEAR	POSITION
96051 	VOLKSWAGEN				
	ARTEON	2.0 TDI	DIESEL	17/20	POST TURBO
	PASSAT B8	2.0 TDI	DIESEL	14/	POST TURBO

#OEM 04L906088CM

PRODUCT	MODEL	ENGINE	FUEL	YEAR	POSITION
96052 	VOLKSWAGEN				
	CRAFTER 30-35	2.0 TDI	DIESEL	11/16	PRE CAT
	CRAFTER 30-50	2.0 TDI	DIESEL	11/16	PRE CAT

#OEM 03L906088HB

EGTS SENSOR

PT200



EXHAUST GAS TEMPERATURE SENSOR ABGASTEMPERATUR

PRODUCT	MODEL	ENGINE	FUEL	YEAR	POSITION
 <p>96053</p>	AUDI				
	A3	1.6 TDI	DIESEL	18/20	PRE DPF
	Q2	1.6 TDI	DIESEL	18/	PRE DPF
	#OEM 04L906088DH				
	SEAT				
	ARONA	1.6 TDI	DIESEL	17/	PRE DPF
	ATECA	1.6 TDI	DIESEL	16/	PRE DPF
	IBIZA V	1.6 TDI	DIESEL	17/	PRE DPF
	#OEM 04L906088DH				
	SKODA				
	KAMIQ	1.6 TDI	DIESEL	19/	PRE DPF
	KAROQ	1.6 TDI	DIESEL	17/	PRE DPF
	OCTAVIA III	1.6 TDI	DIESEL	17/	PRE DPF
	SCALA	1.6 TDI	DIESEL	19/	PRE DPF
	SUPERB III	1.6 TDI	DIESEL	15/	PRE DPF
	#OEM 04L906088DH				
	VOLKSWAGEN				
	GOLF VII	1.6 TDI	DIESEL	16/	PRE DPF
	PASSAT B8	1.6 TDI	DIESEL	14/	PRE DPF
	POLO VI	1.6 TDI	DIESEL	17/	PRE DPF
	T-CROSS	1.6 TDI	DIESEL	18/	PRE DPF
T-ROC	1.6 TDI	DIESEL	18/	PRE DPF	
#OEM 04L906088DH					

EGTS SENSOR

PT200



EXHAUST GAS TEMPERATURE SENSOR ABGASTEMPERATUR

PRODUCT	MODEL	ENGINE	FUEL	YEAR	POSITION
 <p>96054</p>	AUDI				
	A3	1.6 TDI - CRKB	DIESEL	14/20	PRE CAT
	#OEM 04L906088K				
	SEAT				
	LEON	1.6 TDI	DIESEL	12/16	PRE CAT
	LEON SC	1.6 TDI	DIESEL	13/16	PRE CAT
	LEON ST	1.6 TDI	DIESEL	13/	PRE CAT
	#OEM 04L906088K				
	SKODA				
	OCTAVIA III	1.6 TDI	DIESEL	13/	PRE CAT
	KAROQ	1.6 TDI	DIESEL	17/	PRE CAT
	#OEM 04L906088K				
	VOLKSWAGEN				
	GOLF VII	1.6 TDI	DIESEL	13/	PRE CAT
	#OEM 04L906088K				

PRODUCT	MODEL	ENGINE	FUEL	YEAR	POSITION
 <p>96055</p>	AUDI				
	A3	1.6 TDI - CXXB	DIESEL	13/17	PRE CAT
	Q2	1.6 TDI	DIESEL	18/	PRE CAT
	#OEM 04L906088BD - 04L906088CE				

CONTINUING...

EGTS SENSOR

PT200



EXHAUST GAS TEMPERATURE SENSOR ABGASTEMPERATUR

PRODUCT	MODEL	ENGINE	FUEL	YEAR	POSITION
 96055	SEAT				
	ARONA	1.6 TDI	DIESEL	17/	PRE CAT
	IBIZA V	1.6 TDI	DIESEL	17/	PRE CAT
	LEON	1.6 TDI CXXA-CXXB	DIESEL	12/	-
	LEON SC	1.6 TDI CXXA-CXXB	DIESEL	13/	PRE CAT
	LEON ST	1.6 TDI CXXA-CXXB	DIESEL	13/	PRE CAT
	#OEM 04L906088CE				
	SKODA				
	KAMIQ	1.6 TDI	DIESEL	17/	PRE CAT
	OCTAVIA III	1.6 TDI CXXA-CXXB	DIESEL	12/	PRE CAT
	SCALA	1.6 TDI	DIESEL	19/	PRE CAT
	SUPERB	1.6 TDI	DIESEL	15/	PRE CAT
	#OEM 04L906088CE				
	VOLKSWAGEN				
GOLF VII	1.6 TDI CXXA-CXXB	DIESEL	13/	PRE CAT	
PASSAT B8	1.6 TDI	DIESEL	14/	PRE CAT	
POLO VI	1.6 TDI	DIESEL	17/	PRE CAT	
T-CROSS	1.6 TDI	DIESEL	18/	PRE CAT	
T-ROC	1.6 TDI	DIESEL	18/	PRE CAT	
#OEM 04L906088BD - 04L906088CE					

EGTS SENSOR

PT200



EXHAUST GAS TEMPERATURE SENSOR ABGASTEMPERATUR

PRODUCT	MODEL	ENGINE	FUEL	YEAR	POSITION
 <p>96056</p>	AUDI				
	Q2	1.6 TDI	DIESEL	18/	POST CAT
	#OEM 04L906088BF				
	SEAT				
	ARONA	1.6 TDI	DIESEL	17/	POST CAT
	ATECA	1.6 TDI	DIESEL	16/	POST CAT
	IBIZA V	1.6 TDI	DIESEL	17/	POST CAT
	LEON SC	1.6 TDI	DIESEL	16/	POST CAT
	LEON ST	1.6 TDI	DIESEL	16/	POST CAT
	#OEM 04L906088BF				
	SKODA				
	KAMIQ	1.6 TDI	DIESEL	19/	POST CAT
	KAROQ	1.6 TDI	DIESEL	17/	POST CAT
	OCTAVIA III	1.6 TDI	DIESEL	17/	POST CAT
	SCALA	1.6 TDI	DIESEL	19/	POST CAT
	SUPERB III	1.6 TDI	DIESEL	15/	POST CAT
	#OEM 04L906088BF				
	VOLKSWAGEN				
	CRAFTER	2.0 TDI	DIESEL	16/	POST CAT
	GOLF VII	1.6 TDI	DIESEL	16/	POST CAT
	GRAND CALIFORNIA	2.0 TDI	DIESEL	19/	POST CAT
	PASSAT B8	1.6 TDI	DIESEL	14/	POST CAT
	POLO VI	1.6 TDI	DIESEL	17/	POST CAT
	T-CROSS	1.6 TDI	DIESEL	18/	POST CAT
	T-ROC	1.6 TDI	DIESEL	18/	POST CAT
	#OEM 04L906088BF				

EGTS SENSOR





PT200



EXHAUST GAS TEMPERATURE SENSOR ABGASTEMPERATUR

PRODUCT	MODEL	ENGINE	FUEL	YEAR	POSITION
96057	VOLKSWAGEN PASSAT B8 #OEM 04L906088CP	 2.0 TDI	 DIESEL	 14/	 PRE DPF



PRODUCT	MODEL	ENGINE	FUEL	YEAR	POSITION
96058	AUDI A3 #OEM 04L906088DA	 1.6 TDI	 DIESEL	 13/20	 PRE DPF
	SEAT LEON ST LEON SC #OEM 04L906088DA	1.6 TDI	DIESEL	16/ 16/18	PRE DPF PRE DPF
	VOLKSWAGEN PASSAT B8 #OEM 04L906088DA	1.6 TDI	DIESEL	14/	PRE DPF



EGTS SENSOR

PT200



EXHAUST GAS TEMPERATURE SENSOR ABGASTEMPERATUR

PRODUCT	MODEL	ENGINE	FUEL	YEAR	POSITION
96059	VOLKSWAGEN PASSAT B8	 2.0 TDI	 DIESEL	 14/	 PRE DPF

#OEM 04L906088CN



CROSS REFERENCE PT200

EXHAUST GAS TEMPERATURE SENSOR ABGASTEMPERATUR



OEM

OEM

MTE-THOMSON

**CROSS
REFERENCE**

ALFA ROMEO

51825680	9551
51825681	9565
51802893	96030
51830621	96028
51867072	96028
55199541	96030
55204763	96017
55204765	9500
55207108	96030
55220508	96028
55229330	96028
55271704	96036
55279495	96036
059.906.088.CP	96019

AUDI

036.906.088.C	9587
038.906.088.A	9636
038.906.088.C	9607
038.906.088.D	9635
038.906.088.E	9607
03G.906.088.AF	9588
03G.906.088.AK	9607
03G.906.088.AP	9637
03G.906.088.BA	9575
03G.906.088.D	9506
03G.906.088.J	9597
03G.906.088.R	9692
03L.906.088.AB	9515
03L.906.088.AG	96009
03L.906.088.BS	9597
03L.906.088.BT	96011
03L.906.088.CC	9504
03L.906.088.CH	9542
03L.906.088.E	9611
03L.906.088.F	96010
03L.906.088.P	9618
03L.906.088AJ	9505

CROSS REFERENCE PT200



EXHAUST GAS TEMPERATURE SENSOR ABGASTEMPERATUR

OEM

OEM

MTE-THOMSON

CROSS

AUDI

REFERENCE

04L.906.088	9603
04L.906.088.AE	9603
04L.906.088.BD	96055
04L.906.088.BF	96056
04L.906.088.CE	96055
04L.906.088.DA	96058
04L.906.088.DH	96053
04L.906.088.E	9605
04L.906.088.K	96054
057.906.088.A	96013
057.906.088.B	9657
057.906.088.D	9656
059.906.088.A	9508
059.906.088.AA	9591
059.906.088.AC	9596
059.906.088.AE	9606
059.906.088.AK	9558
059.906.088.AT	9558
059.906.088.BB	9538
059.906.088.BH	9682
059.906.088.BJ	9539
059.906.088.BK	9566
059.906.088.BM	9679
059.906.088.C	9535
059.906.088.CE	9633
059.906.088.CP	96019
059.906.088.H	9630
059.906.088.K	9634
059.906.088.M	9566
059.906.088.P	9589
059.906.088.Q	9629
059.906.088.S	9598
059.906.088.T	9540
06F.906.088.D	9631
07Z.906.088.A	9568
4G0.906.088.AA	96049
4G0.906.088.AN	96049

CROSS REFERENCE PT200



EXHAUST GAS TEMPERATURE SENSOR ABGASTEMPERATUR

CROSS REFERENCE

OEM # OEM # MTE-THOMSON

AUDI

4G0.906.088.H	9678
4G0.906.088.L	96049
4H0.906.088.F	9655
4H0.906.088.G	9664
8K0.906.088	9559
8K0.906.088.C	9574
8W0.906.088.E	96046
8W0.906.088.F	96045
8W0.906.088.Q	96046

DAF

1689812	96003
1612300	96003
1612372	96003
1677124	96004
1689811	96004
1810690	96004
1810691	96003
3468052	96004

FIAT

51779770	96008
51791310	9576
51799538	9551
51807903	9648
51825681	9565
51825683	9676
51861682	96031
55197011	96032
51917398	96002
55190624	9571
55199053	96027
55199543	96028
55200036	9646
55200037	9646
55203808	96029
55204765	9500
55208250	9576

CROSS REFERENCE PT200

EXHAUST GAS TEMPERATURE SENSOR ABGASTEMPERATUR



CROSS REFERENCE

OEM # OEM # MTE-THOMSON

FIAT

55212786	9648
55218471	9551
55228650	96031
55243388	96002
55271703	96036
55271704	96036

FORD

1792122	96050
8C3Z.5J213.D	9550
8C3Z.5J213.B	9584
AB3A-12B591-AA	9673
AC3Z-5J213-B	9584
AC3Z-5J213-C	9665
BK2A-12B591-AB	96050
CC1A-12B591-BB	9686
EB3G-12B591-FA	9675
EB3G-12B591-FB	9675

GM - CHEVROLET

12598444	9523
12622555	9578
12633560	9549
12636612	9593
12637488	9524
25183660	96005
25183664	96034
25186658	96038
55489472	9565
55499997	96047
55557600	9577
55562433	96048
55564270	9690
55564977	9503
55566185	9565
55566575	9564
55566631	9555
55574183	96043

CROSS REFERENCE PT200

EXHAUST GAS TEMPERATURE SENSOR ABGASTEMPERATUR



CROSS REFERENCE

OEM	# OEM	# MTE-THOMSON
GM - CHEVROLET	55578722	9690
	55578800	96016
	55578799	9691
	96868940	96039
	96868946	96038
GMC	12623113	9523
	12636612	9593
	12637488	9524
IVECO	504102603	9676
	69502363	9694
	5801291815	9676
JEEP	55254789	96036
	55271493	96036
LANCIA	55207108	96030
	55228650	96031
MERCEDES-BENZ	000.905.01.32	9525
	000.905.03.32	9672
	000.905.06.32	9661
	000.905.07.01	9639
	000.905.08.05	9687
	000.905.14.05	9590
	000.905.26.05	9671
	000.905.33.00	9590
	000.905.35.05	9662
	000.905.43.05	9529
	000.905.52.05	9502
	000.905.56.08	9614
	000.905.64.04	9553
	000.905.67.04	9532
	000.905.68.04	9563
000.905.69.04	9652	

CROSS REFERENCE PT200



EXHAUST GAS TEMPERATURE SENSOR ABGASTEMPERATUR

OEM

OEM

MTE-THOMSON

CROSS

MERCEDES-BENZ

000.905.70.04	9639
000.905.71.04	9651
000.905.78.01	96035
000.905.79.01	9513
000.905.85.01	9639
000.905.87.00	9641
000.905.88.00	9671
000.905.88.04	9614
000.905.89.00	9533
000.905.89.04	9536
000.905.90.00	9613
001.905.06.00	9527
001.905.07.00	9556
001.905.09.00	9669
001.905.22.00	9652
001.905.23.00	9651
001.905.24.00	9667
001.905.27.99	9662
001.905.28.00	9662
001.905.29.00	9643
001.905.30.00	9501
005.153.10.28	9518
005.153.11.28	9552
005.153.20.28	9527
005.153.22.28	9614
005.153.41.28	9502
005.153.42.28	9644
005.153.45.28	9592
005.153.90.28	9613
005.153.92.28	9530
006.153.05.28	9695
006.153.06.28	9696
006.153.07.28	9697
007.153.34.28	9614
007.153.62.28	9518
007.153.63.28	9552
007.153.65.28	9658

REFERENCE

CROSS REFERENCE PT200



EXHAUST GAS TEMPERATURE SENSOR ABGASTEMPERATUR

CROSS REFERENCE

OEM # **OEM** # **MTE-THOMSON**

MERCEDES-BENZ

007.153.66.28	9526
007.153.67.28	9527
007.153.74.28	9528
007.153.75.28	9502
007.153.76.28	9644
007.153.78.28	96035
007.153.84.28	9529
007.153.84.28	9644
007.153.86.28	9642
007.153.88.28	9613
007.153.90.27	9563
007.153.90.28	9563
007.153.91.28	9530
007.153.92.28	9640
007.153.94.28	9556
007.153.95.28	9614
007.153.96.28	9650
007.153.98.28	9592
007.153.99.28	9554
008.153.22.28	9553
008.153.27.28	9563
008.153.28.28	9640
008.153.34.28	9531
008.153.35.28	9517
008.153.36.28	9532
008.153.37.28	9532
008.153.40.28	9533
008.153.41.28	9537

NAVISTAR

2593754C91	9685
2593755C91	9684
2593756C91	9683
2593753C92	96025

OPEL

855255	96044
855286	9693

CROSS REFERENCE PT200

EXHAUST GAS TEMPERATURE SENSOR ABGASTEMPERATUR



OEM

OEM

MTE-THOMSON

**CROSS
REFERENCE**

OPEL

855287	9688
855387	9565
855410	9645
855412	9647
855425	9577
855415	96033
855457	9685
855460	9691
855505	96006
855526	9691
855574	9564
1247292	9690
1247634	96001
1249073	96002
25183663	96022
4803548	96022
4818659	96022
5855377	9555
5855388	9688
55190617	96006
55250523	96036
55270986	96036
55355404	9645
55496933	96001
55557466	96033
55558578	9647
55565652	96044
55566086	96037
55566621	96041
55566817	9688
55571194	96040
55571362	96041
55574938	96043
55578800	96016
55591173	96001
95519373	96002
96474598	96022

CROSS REFERENCE PT200



EXHAUST GAS TEMPERATURE SENSOR ABGASTEMPERATUR

CROSS REFERENCE

OEM	# OEM	# MTE-THOMSON
OPEL	96868946	96038
	96994636	96005
	96994638	96034
PORSCHE	059.906.088.BP	9545
	059.906.088.BR	9594
	059.906.088.BN	9680
RENAULT TRUCKS	74.20.889.280	9668
	74.21.412.472	9699
SAAB	55575039	9688
SCANIA	1882567	96023
	2265872	96023
	2253825	96023
SEAT	03G.906.088.AC	9586
	03G.906.088.AF	9588
	03G.906.088.AM	9597
	03G.906.088.D	9506
	03G.906.088.E	9628
	03G.906.088.F	9562
	03G.906.088.L	96015
	03L.906.088.AB	9515
	03L.906.088.AJ	9505
	03L.906.088.CC	9504
	03P.906.088.D	9542
	03L.906.088.FG	9618
	03P.906.088.A	9534
	03P.906.088.E	9608
	045.906.088.D	9573
	045.906.088.F	9609
	045.906.088.G	9601
	045.906.088.J	9600
	04L.906.088	9603

CROSS REFERENCE PT200



EXHAUST GAS TEMPERATURE SENSOR ABGASTEMPERATUR

CROSS REFERENCE

OEM # **OEM** # **MTE-THOMSON**

SEAT

04L.906.088.BF **96056**
04L.906.088.CE **96055**
04L.906.088.DA **96058**
04L.906.088.DH **96053**
04L.906.088.E **9605**
04L.906.088.K **96054**

SKODA

038.906.088.B **9632**
03G.906.088.AC **9586**
03G.906.088.AF **9588**
03G.906.088.AK **9607**
03G.906.088.AN **9597**
03G.906.088.D **9506**
03L.906.088.AJ **9505**
03L.906.088.CC **9504**
03L.906.088.CH **9542**
03L.906.088.P **9618**
03P.906.088.A **9534**
03P.906.088.C **9608**
03P.906.088.D **9542**
045.906.088.D **9573**
045.906.088.F **9609**
045.906.088.G **9601**
045.906.088.J **9600**
04L.906.088.BF **96056**
04L.906.088.CE **96055**
04L.906.088.DH **96053**
04L.906.088.E **9605**
04L.906.088.K **96054**
06F.906.088.D **9631**

SMART

000.905.08.32 **9677**
000.905.17.32 **9677**

SUZUKI

18213-79J60 **96028**

CROSS REFERENCE PT200

EXHAUST GAS TEMPERATURE SENSOR ABGASTEMPERATUR



MTE-THOMSON

CROSS REFERENCE

OEM # **OEM** # **MTE-THOMSON**

VAUXHALL

55557466	96033
55564977	9585
55566185	9565
55575039	9688
55578800	96016
55588650	9690
96868946	96038

VOLKSWAGEN

036.906.088.C	9587
038.906.088.B	9632
03G.906.088	9514
03G.906.088.AC	9586
03G.906.088.AF	9588
03G.906.088.AR	9626
03G.906.088.AT	9597
03G.906.088.D	9506
03G.906.088.E	9628
03G.906.088.F	9562
03G.906.088.L	96015
03G.906.088.K	9514
03K.906.088.B	9541
03L.906.088.AB	9515
03L.906.088.AF	9511
03L.906.088.AJ	9505
03L.906.088.AQ	9623
03L.906.088.AT	9612
03L.906.088.BN	9620
03L.906.088.BP	9621
03L.906.088.BQ	9622
03L.906.088.C	96026
03L.906.088.CC	9504
03L.906.088.CE	9507
03L.906.088.CH	9542
03L.906.088.CQ	9653
03L.906.088.DC	9615
03L.906.088.DE	9638
03L.906.088.DF	9602

CROSS REFERENCE PT200

EXHAUST GAS TEMPERATURE SENSOR ABGASTEMPERATUR



MTE-THOMSON

OEM

OEM

MTE-THOMSON

CROSS

REFERENCE

VOLKSWAGEN

03L.906.088.DJ	9619
03L.906.088.DN	9516
03L.906.088.DP	9602
03L.906.088.ED	9581
03L.906.088.EE	9582
03L.906.088.EF	9663
03L.906.088.EJ	9543
03L.906.088.EK	9654
03L.906.088.ES	9659
03L.906.088.FB	9615
03L.906.088.FE	9510
03L.906.088.FF	9602
03L.906.088.FG	9618
03L.906.088.FQ	9512
03L.906.088.GR	9638
03L.906.088.HB	96052
03L.906.088.HG	9602
03L.906.088.HK	9622
03L.906.088.J	9557
03L.906.088.JK	9512
03L.906.088.L	9580
03L.906.088.T	9544
03L906088DH	9567
03L906088DM	9572
03L906088G	9569
03P.906.088.C	9608
03P.906.088.D	9542
045.906.088.D	9573
045.906.088.F	9609
045.906.088.G	9601
045.906.088.J	9600
04L.906.088	9603
04L.906.088.AE	9603
04L.906.088.BD	96055
04L.906.088.BF	96056
04L.906.088.CE	96055
04L.906.088.CM	96051

CROSS REFERENCE PT200



EXHAUST GAS TEMPERATURE SENSOR ABGASTEMPERATUR

OEM

OEM

MTE-THOMSON

CROSS

REFERENCE

VOLKSWAGEN

04L.906.088.CN	96059
04L.906.088.CP	96057
04L.906.088.DA	96058
04L.906.088.DH	96053
04L.906.088.E	9605
04L.906.088.K	96054
057.906.088.A	96013
059.906.088.A	9508
059.906.088.AA	9591
059.906.088.AB	9583
059.906.088.AC	9596
059.906.088.AD	9649
059.906.088.BJ	9539
059.906.088.BP	9545
059.906.088.BR	9594
059.906.088.BN	9680
059.906.088.BS	9595
059.906.088.C	9535
059.906.088.CE	9633
059.906.088.CL	9539
059.906.088.CP	96019
059.906.088.K	9634
059.906.088.P	9589
059.906.088.S	9598
059.906.088.T	9540
06F.906.088.D	9631
070.906.088	9616
070.906.088.A	9561
070.906.088.AA	9570
070.906.088.AC	9610
070.906.088.AD	9546
070.906.088.AE	9627
070.906.088.AF	9599
070.906.088.D	9660
070.906.088.E	9674
076.906.088.A	9681
076.906.088.C	9625

CROSS REFERENCE PT200

EXHAUST GAS TEMPERATURE SENSOR ABGASTEMPERATUR



OEM

OEM

MTE-THOMSON

CROSS REFERENCE

VOLKSWAGEN

076.906.088.E	9624
07Z.906.088.A	9568
07Z.906.088.C	9547
07Z.906.088.N	9579
07Z.906.088.P	9548

VOLVO

20451990	9668
20889280	9668
21126692	96000
21164792	9698
21225020	9699
21412472	9699
30729648	9509
30751456	96018
31293031	9522
31293032	9604
31293172	96018
31303026	96024
31319265	96021
31319840	96021
31319842	96024
31370463	96018
31370466	96021
31370468	96024
31370692	96020
31431045	96018
31431047	9604
31431048	96021
31431049	96024
50422509	96018





MTE-THOMSON IND. E COM. LTDA.

AVENIDA MOINHO FABRINI, 1033
CEP 09862-900
SÃO BERNARDO DO CAMPO SP BRASIL
PHONE: (55) (11) 4393 4343
FAX: (55) (11) 4393 4361
mte@mte-thomson.com.br
www.mte-thomson.com.br

Cooling and
Engine Management
Competence

MTE-THOMSON INC. - USA DIVISION

35 SW 12TH AVE - BLDG #35 SUITE 112
DANIA BEACH - FL 33004
PHONE: (1) (954) 564-5955
FAX: (1) (954) 564-5988
noto@mte-thomson.com.br
www.mte-thomson.com

MTE-THOMSON EUROPE

ARSTERDAMM, 82
28277 - BREMEN - GERMANY
PHONE: (49) (0) 421 875027
FAX: (49) (0) 421 876422
stevan.manzan@mte-thomson.com.br
www.mte-thomson.de

CatE-MTE
WEB CATALOG



TecAlliance
Certified Data Supplier



BRAZIL - COPYRIGHT © 2017 MTE-THOMSON
15th EDITION - REVISED 10/2021

